



Air-Jacketed DH Invitrocell CO₂ Incubator

Models
NU-5700
NU-5700E

Operation and Maintenance Manual

February 2024
Revision 7



For 115 Vac, 50/60 Hz Only

Manufactured By:
NuAire, Inc.
2100 Fernbrook Lane
Plymouth, MN 55447
Toll-Free: 1-800-328-3352
In Minnesota: (763)-553-1270
Fax: (763)-553-0459

Air-Jacketed DHD Invitrocell CO₂ Incubator
Operation and Maintenance Manual
NU-5700 & NU-5700E

Table of Contents

Section No. 1.....General Description
 Section No. 2.....Performance Parameters and Features
 Section No. 3.....Models & Features
 Section No. 4.....Test Performance & Procedures
 Section No. 5.....Warranty Disclaimer
 Section No. 6.....Shipments
 Section No. 7.....Installation
 Section No. 8.....DH Operation
 8.1Sterility
 8.2Humidity
 8.3Control System Introduction
 8.4Front Control Panel
 8.5Rear Component Panel
 8.6Front Component Panel
 8.7Run Mode Operator Interactions
 8.8Standby Mode Operator Interactions
 8.9Diagnostic Interactions
 8.10Resetting the Electronic Software
 Section No. 9.....Calibration
 9.1Chamber Temperature Calibration
 9.2Door and Perimeter Heater Adjustments Affecting Temperature Calibration
 9.3Setting Air Injections
 9.4CO₂ Calibration
 Section No. 10.....Maintaining Your DH Invitrocell
 10.1Chemical Decontamination
 10.2Power Loss Recovery Mode
 10.3Shutting Down the Incubator
 10.4Automated Filter Change Notification
 Section No. 11.....Error Indicators & Troubleshooting
 Section No. 12.....Communication Outputs
 Section No. 13.....Electrical/Environmental Requirements
 Section No. 14.....Disposal and Recycle

MANUAL DRAWINGS

BCD-18412 Dimensioned Assembly NU- 5700/E
 BCD-19904 DH/D interior prep
 BCD-15669 Rear Component Panel Assembly

ASSEMBLY DRAWINGS

BCD-18316 Front Component Panel
 BCD-15177 Electronics Panel Assembly
 BCD-20374 Sensor Bay Assembly
 BCD-18315 Tubing Diagram
 BCD-18317 Incubator Right Hinge Door Assembly
 BCD-18321 Incubator Left Hinge Door Assembly

ELECTRICAL SCHEMATICS

BCD-17641 Electrical Schematic, NU-5700/E
 BCD-18007 Main Control Board Electrical Schematic

DH Direct Heat Automatic CO₂ Incubator Models: NU-5700 and NU-5700E Operation and Maintenance Manual

1.0 General Description

The NuAire Direct Heat (DH) Automatic CO₂ Direct Heat Incubator has been designed to provide a reliable controlled in-vitro environment for optimum tissue cell culture growth. The chamber also provides an environment for the storage and preservation of embryos, gametes and animal tissue cell cultures intended for research at or near body temperature. There are five parameters that contribute to optimum growth conditions.

These are:

- Humidity
- Precise temperature control
- Precise CO₂ control
- Sterility
- Reliability

Like all NuAire equipment, this Incubator has been designed to provide the highest quality standards of performance with matching computer technology, precise temperature control, and CO₂ gas control system combining state-of-the-art technology with years of design, quality, and manufacturing experience.

1.1 Incubator Chamber

The design and size of the DH inner chamber provides a large capacity (5.7 cu. ft.), and ease of use. The chamber walls are directly heated by physically attached foil heating elements on the sides, bottom, top, and back of the chamber, providing a temperature uniformity of $\pm 0.3^{\circ}\text{C}$. A high-density insulation that has a high "R" rating covers the complete outer surfaces of the Incubator inner chamber.

1.2 Incubator Closed Loop Chamber Sample Circulation System & HEPA Filter

A continuous operating air pump draws environmental sample from the chamber and circulates it through a HEPA filter capsule then through sensors that measure CO₂ volume (as a percentage) in the chamber for monitoring and control.

1.3 Incubator Control Electronics

The NuAire Incubator Control Electronics is a state-of-the-art microcomputer-based control system specifically designed to service the precise control requirements of the chambers environment, providing optimum programmable conditions for culture growth. The microcomputer is "user-friendly" and provides a 5x7 inch LCD screen which provides operating control parameters, status indicators, additional key operational parameters, and an imbedded touch panel to permit efficient operator entry of data.

The microcomputer is supported with Read Only Memory (ROM) containing executable software, Random Access Memory (RAM) for temporary storage, and Electronically Erasable Programmable Read Only Memory (EEPROM) for control set points and parameters. The EEPROM provides for indefinite storage of these values during periods of power off or power interruption (power fault tolerant).

1.4 Incubator CO₂ Control

The NuAire direct heat Incubator incorporates a microprocessor-based, non-dispersive infrared CO₂ induction sensor. The amount of energy received at the detector is an approximate logarithmic function of the CO₂ concentration in the gas between source and detector. The wavelengths used are absorbed only by CO₂ making the measurement insensitive to other components, such as water vapor. Detector linearization is performed with 32-bit digital accuracy. Advanced design provides a very stable output minimizing drift and requiring less frequent calibration. The output is digital, alleviating errors brought about by analog signals. Calibration of this control is accomplished by a zero & span calibration done on the sensor and a display off- set calibration. These calibrations are accessible through the *NU-TOUCH LCD* located on the front of the unit.

1.5 Incubator Construction

The outer shell of the air-jacketed Incubator is cold-rolled steel with a powder coat paint finish. The front frame surface of the outer shell is heated with a foil type heater directly attached behind the front perimeter opening.

The front frame perimeter heater, as well as the outer front door heater is duty cycle controlled (manually adjusted for specific ambient conditions) to balance the heat that reaches the chamber and thus reduces the possibility of condensation forming on the inner glass door and the inner chamber walls.

The inner chamber is 16-gauge, type 304L, polished stainless steel using crevice-free construction, which provides an easily cleanable inert surface that does not in itself promote biological growth. In addition, all shelves, shelf supports, and guide rails are easily removable and can be autoclaved separately if so desired.

Remember: The chamber environment is not selective. The growth environment is applied equally to all microorganisms (specimens and contaminants) within the chamber.

1.6 Incubator Humidity

A relative humidity level of up to 90% is achieved in the Incubator by the use of a stainless-steel pan filled with **DISTILLED WATER** no purer than 1 megaohm and placed on the bottom of the chamber. It is necessary to set the duty cycle of the door and front perimeter heater in proper proportions to reduce the possibility of condensation forming on the glass inner door and the chamber walls. It is also important to thoroughly wipe the walls and the glass door clean before adding the humidity water pan. Condensation will occur more readily at contamination points. There is no electronic sensing and thus no automatic control of the humidity level in the air jacketed Incubator. An air pump injects fresh air into the chamber at a preset duty cycle to reduce condensation forming on the chamber walls and front glass door. The air injections are settable by the user to help control condensation. (See section 9.3 for this option.)

1.7 Cabinet Ventilator Fan

Two axial fans are mounted to the bottom cover panel of the Incubator and run continuously when the unit is switched on. These fans pull air into the cabinet shell through the top panel louver openings and discharge it out of the bottom of the unit. The operation of this fan is necessary to assure accurate chamber temperature control over the 60°F to 85°F (15°C to 30°C) ambient temperature range that the equipment may see.











1.8 Safety Instructions

These safety instructions describe the safety features of the INVITROCELL Incubator.

The incubator has been manufactured using the latest technological developments and has been thoroughly tested before delivery. It may, however, present potential hazards if it is not used according to the intended purpose or outside of operating parameters. Therefore, the following procedures must always be observed:

- The incubator must be operated only by trained and authorized personnel.
- For any operation of this unit, the operator must prepare clear and concise written instructions for operating and cleaning, utilizing applicable safety data sheets, plant hygiene guidelines, and technical regulations, in particular.
 - which decontamination measures are to be applied for the incubator and accessories
 - which protective measures apply while specific agents are used
 - which measures are to be taken in the case of an accident
- Repairs to the device must be carried out only by trained and authorized expert personnel.
- Keep these operating instructions close to the unit so that safety instructions and important information are always accessible.
- Should you encounter problems that are not detailed adequately in the operating instructions, please contact your NuAire Representative of NuAire Technical Services.

1.9 Explanation of symbols

Symbol	Description
	Safety alert symbol indicates a potentially hazardous situation which, if not avoided, could result in death of serious injury.
	Safety alert symbol indicates a potentially hazardous situation which, if not avoided, may result in minor or moderate injury.
CAUTION:	CAUTION used without the safety alert symbol indicates a potentially hazardous situation which, if not avoided, may result in property damage.
	Potential electrical hazard, only qualified person to access.
	Biohazard
	Ground Earth
	Hazardous Gases! Personal Protection Equipment Required.
	Chemical Hazard
	Flammable Hazard
	Lead Free
	Hot Surface Burn Potential
	Attention accompanies information or important symbol

2.0 Performance Parameters and Features

- Both the interior and exterior of the DH are constructed of 18 to 16-gauge steel. The interior is highly polished type 304 L 16-gauge stainless steel, using crevice-free construction. All exposed edges are deburred to ensure no sharp edges. The exterior is cold rolled 16- & 18-gauge steel finished in a powder-coated polyurethane finish, which is resistant to chemicals and easily cleaned using mild household detergents.
- The DH's microcomputer temperature control system has two temperature sensors located inside the chamber at the back wall. The temperature sensors compare the values to a set point and execute a differential control algorithm that energizes a solid-state switch, supplying power to the heaters.
- Easily removable inner shelves and rails for sterilization.
- Up to 16 shelves can be placed inside the chamber (4 shelves are shipped with each DH).
- Space-age high-temperature material is used to insulate the inner chamber walls.
- Foil heaters are directly attached to the chamber walls and the top and bottom surfaces of the inner chamber.
- Most electronics, motors, pumps, and valves are fully accessible from the back of the unit.
- Access to the filters and CO₂ sensor in the sensor bay in the front of the incubator.
- A CO₂ sample port is provided in the center of the inner glass door to check the concentration of CO₂ in the chamber.
- The CO₂ percentage is controlled by a solid-state gas infrared sensor using a single light source with dual-wavelength detection, providing accurate monitoring of CO₂.
- Automatic recovery of the CO₂ level, after a 1-minute door opening to $5.0 \pm 0.5\%$ is in 5 minutes on average.
- The outer door includes an internal radiant heater in order to minimize condensation on the inner glass door. A magnetic outer door gasket helps to ensure a tight seal against the cabinet.
- The inner glass door is 3/16" tempered with smooth-ground edges and seals are tight against a silicone rubber gasket. The door latch is cam action. A momentary switch monitors the door position, the position being opened or closed.
- All control electronics are protected with a circuit breaker that may trip at 110% of loading rating but will trip at 145% of load rating in less than 2 seconds.

NOTE: Should the circuit breaker open (pop-out button will appear), merely depress to reset.

- The Incubator has factory-installed adjustable leveling legs to compensate for uneven laboratory surfaces.

3.0 Models & Features

3.1 Dimensions (see also Specification Drawing BCD-18412)

Overall Dimensions - inches (mm):	Model NU-5700/E
Height:	Exterior: 36.188 inches (894 mm)
Width:	25.500 inches (648 mm)
Depth:	27.500 inches (699 mm)
Footprint:	22.625 inches (575 mm) wide x 20.825 inches (530 mm) deep
Height:	Interior: 24.000 inches (610 mm)
Width:	20.250 inches (514 mm)
Depth:	20.678 inches (525 mm)

Shelf Capacity:

Size:	18.00 Inches (457mm) wide x 18.75 Inches (476mm) deep
Supplied:	4 Shelves
Maximum Capacity:	16 Shelves
Maximum Weight Capacity	25 lbs. per DHD shelf 125 lbs. per DHD Incubator

NOTE: Make sure the shelf is empty before changing position or removing.

Water Pan:

Dimensions:	Mean Length	12.0 inches (305mm)
	Mean Width	10.0 inches (254mm)
	Depth	1.5 inches (38mm)
Capacity:	Maximum	2.0 Liters
	Recommended Fill	1.5 Liters

3.2 Performance Parameters:

- Temperature Range: 5°C to 55°C (5°C above ambient to 30°C maximum ambient)
- Temperature Uniformity: $\pm 0.3^{\circ}\text{C}$ @ 37°C.
- Temperature Accuracy: $\pm 0.1^{\circ}\text{C}$.
- CO₂ Range: 0.1 to 20%. (0.0 set point idles system)
- CO₂ Accuracy: $\pm 0.1\%$
- CO₂ Recovery: Up to 5% +0.2/-0.5 in 5 minutes average.
- Temperature Recovery: 0.12°C/minute Average
- Temperature Display Resolution: 0.1°C
- CO₂ Display Resolution: 0.1%
- Door and Perimeter: Proportional base duty cycle based on Temperature set point and 0-100% manually adjustable to adapt to ambient conditions.
- Temperature Sensor Type: Precision Integrated Circuit
- CO₂ Control Logic: Fixed Algorithm/Manual Environmental Adaptable.
- CO₂ Sensor Type: Infrared single source dual wavelength
- Sensor Bay Temp: Chamber Set Point +3.5 Degree C.
- Connectors on rear panel are provided for Dry contact remote alarm, RS-485 2way communication, and 4 – 20 mA analog output signals for system performance.

NOTE: Performance ratings apply ONLY when the Incubator is installed and set up properly per the instructions in the manual, and it has stabilized at all set points and is in a stable environment. See sections 8 and 9 for proper set up.

While Idle, the system will not inject gas and will not alarm.

3.3 Standard Items Packed with Unit

- Four (4) stainless steel shelves
- Eight (8) stainless steel shelf brackets
- One (1) water pan
- Gas supply tube(s)
- Access port plug - vented
- One (1), 2 meter (6.5 ft.) electrical cord 10 Amp 18 awg with 70°C rated jacket *
- Operation and Maintenance Manual
- Operating Instructions

*Do not replace electrical cord with an inadequately rated cord.
A factory supplied replacement is recommended.

3.4 Consult Factory for additional Accessories (Ordered Separately)

ITEM	DESCRIPTION	REV	CO	DESCRIPTION	DATE	DFTR	CHKD
1	POWER CORD	D	002530	UPDATED DIMENSIONS NOTE, REMOVED RH TANK & N2 FILTER, MOVED SERIAL LABEL	11/6/2023	RN	SD
2	DISPLAY SCREEN						
3	CO2 SAMPLE PORT						
4	ACCESS PORT 1-1/8" [28.6mm]						
5	USB CONNECTION PORT COVER						
6	ON/OFF SWITCH						
7	CIRCUIT BREAKER						
8	AC POWER CORD CONNECTION						
9	CO2 INLET						
10	AIR FILTER						
11	CO2 FILTER						
12	4 - 20 MA CONNECTION						
13	RS-485 CONNECTION						
14	REMOTE ALARM CONNECTION						
15	AIR SUPPLY INLET						
16	N2 INLET						
17	PORT PLUG, MODELS W/NO HEATED DECON						
18	SILICON PORT PLUG, MODELS W/HEATED DECON						
19	SENSOR BAY ACCESS PANEL						
20	USB PORT - FRONT						

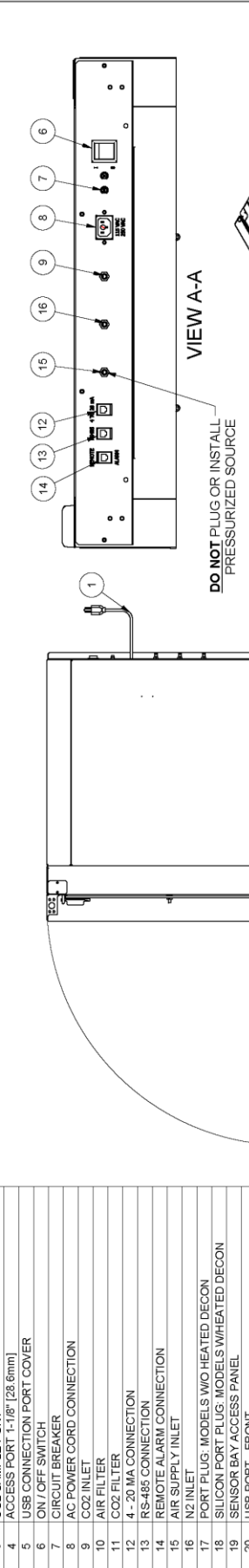

EXTERIOR DIMENSIONS
 36.188" [933.5mm] H / **C**
 23.500" [647.7mm] W / **C**
 27.500" [698.0mm] D

INTERIOR DIMENSIONS
 24.000" [609.6mm] H
 20.250" [514.4mm] W
 20.678" [525.2mm] D

SHELF DIMENSIONS
 18.000" [457.2mm] W
 18.750" [476.3mm] D

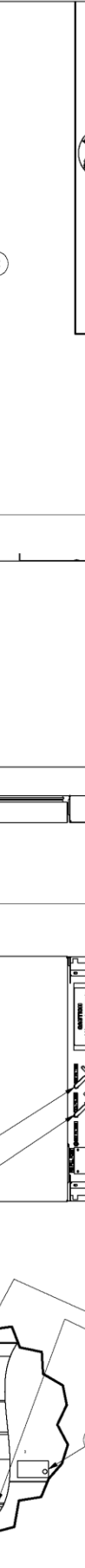
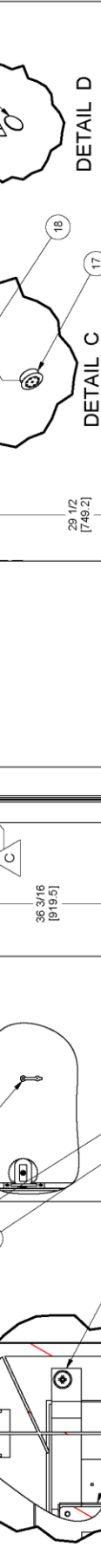
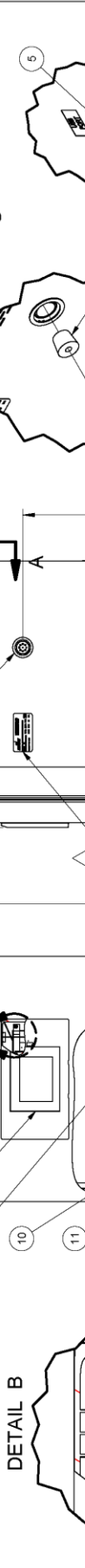
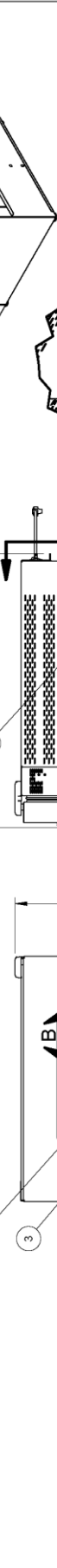
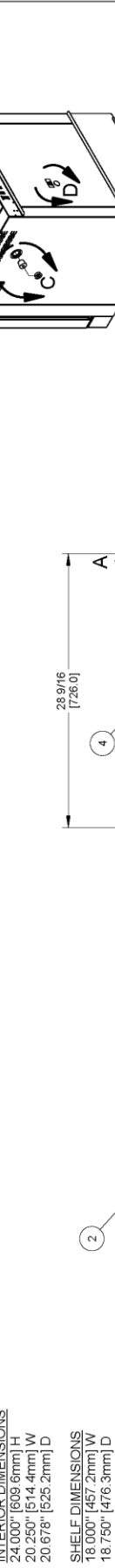

REV	CO	DESCRIPTION	DATE	DFTR	CHKD
D	002530	UPDATED DIMENSIONS NOTE, REMOVED RH TANK & N2 FILTER, MOVED SERIAL LABEL	11/6/2023	RN	SD

TITLE		ASSEMBLY, NU-5700	
DTM	DATE	CRD	SHEET
TH	9/23/2016	KCK	1 OF 1
DRAWING NUMBER		BCD-18412	
		D	

4.0 Test Performance & Procedures

All equipment is thoroughly inspected at the NuAire Factory at the time of shipment. Quality control is maintained by constant surveillance over the product, beginning at the receipt of purchased material and concluding with a final inspection, which certifies the Incubator performance to the specifications. In all instances where product quality cannot be easily assessed on the end item, the product is inspected during sub-assembly fabrication. The following test procedures are conducted on every DH Incubator and a copy of the test report is included with each Incubator.

4.1 Visual Inspection

- Each Incubator is visually inspected to ensure that the interior is clean and free from scratches, nicks, and burrs and that all welds, both interior and exterior are finished.
- Painted surfaces are inspected to be free of scratches, nicks, insufficient covering, and noticeable paint runs.
- The doors open and close freely without binding of the hinges.
- The gasket seals the inner glass door to the Incubator tightly across its entire opening.
- The glass door is free of scratches.

4.2 Electrical Tests

- **Electrical Leakage Test**
All Incubators are required to have primary-circuit filtering to meet EMC (electromagnetic compatibility) regulations. Electrical leakage does not exceed 1.0 milliamperes.
- **Dielectric Voltage – Withstand Test**
1200 VDC (115 volt or 2000 VDC (230-volt units)) is applied between dead metal parts and the hot/neutral power source lead with no electrical breakdown using an Associated Research Model 7564SA Quadchek II, 8106 Omnia 6, or 8006 Omnia 6, or other models.
- **Grounding Continuity**
The resistance between the green bonding conductor of the supply cord and any dead metal part of the cabinet shall not exceed 0.10 ohms.

4.3 Functional Tests

These functional tests are performed on every Incubator over a 48-hour final acceptance test/burn-in period. All failures are noted, corrected, and the failed test is successfully repeated.

- **Control Systems**
All performance and diagnostic functions are exercised to ensure proper operation of control systems, components, and alarms.
- **CO₂ Control**
Each Incubator is calibrated to function at a 5% CO₂ level.
The concentration is checked with an independent calibrated instrument.
Each unit is monitored during the 48-hour burn-in period and only accepted with zero failures.
- **CO₂ Recovery**
Each Incubator is exercised for CO₂ recovery time at the end of the 48-hour burn-in period.
The door is opened for 1 minute to deplete the CO₂.
After the door is closed, the unit shall recover to 5% +0.2 / - 0.5% within a 5-minute period.
- **Temperature**
Each Incubator is monitored for stable temperature control over the 48-hour burn-in period at (37°C).
- **Humidity**
Each unit has a default RH level intended to avoid condensation.
Door and perimeter duty cycles are determined by a Base duty cycle calculation based on the chamber Temperature set point. Automatically adjusted in response to environmental conditions but can be manually adjusted if needed to control condensation and tune in the chamber temperature uniformity for the environment that the incubator is installed in.
If unit is master reset these settings will be changed to a default value of 0.0.
The factory default door and perimeter settings are: **Door: 0.0, Perimeter: 0.0.**

5.0 Warranty

Details regarding product warranties can be found in the published warranty data separate from this manual and included within the data packet sent with the unit.

6.0 Shipments

NuAire, Inc. takes every reasonable precaution to assure that your Incubator arrives without damage. Motor carriers are carefully selected, and shipping cartons have been specifically designed to ensure your purchase arrives safely and undamaged. However, damage can occur in any shipment and the following paragraph outlines those steps you should take on receipt of a NuAire Incubator to be sure that if damage has occurred, the proper claims and actions are taken immediately.

6.1 Damaged Shipments

6.1.1 Terms are F.O.B. factory, unless stated otherwise.

Therefore, it is important to check each shipment before acceptance.

6.1.2 If there is visible damage, the material can be accepted after the driver makes a notation on the consignee's copy of the freight bill. Then an inspection must be made to verify the claim against the carrier. This inspection is the basis of your filing the claim against the carrier.

6.1.3 If concealed damage is found, it is absolutely necessary to NOTIFY THE FREIGHT AGENT AT ONCE and request an inspection. Without this inspection, the transportation company may not accept a claim for loss or damage. If the carrier will not perform the inspection, an affidavit must be prepared stating that he was contacted on a certain date and that he failed to comply with the request. This, along with other papers in the customer's possession, will support the claim.

7.0 Installation

The Incubator is fastened to the base skid, and it is usually the best procedure to leave the skid attached until the Incubator is located in its approximate position to facilitate ease in handling. The base skid can then be removed by removing the two bolts holding the cabinet to the skid. See 18412 for dimensional and feature information about the incubator.

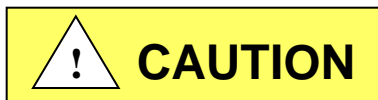

It is recommended that no less than two people are present when the incubator needs to be moved.

Examine the Incubator carefully.

INSPECT both the exterior and the interior for any transit damage before discarding the shipping crate.

7.1 Location

In locating the Incubator, consider all possible conditions that might affect its performance as well as laboratory procedures for its intended purpose. Do not locate near heating or cooling ducts, or next to equipment that generates heat (steam radiators, stoves, ovens, autoclaves, etc.). Avoid direct sunrays and rapidly moving air currents. These conditions adversely affect the even heat dissipation required from the exterior surfaces of the Incubator and may cause the temperature variation in the chamber to exceed specifications as stated in section 3.2. Since the Incubator needs even heat dissipation on all surfaces in order to maintain an internal temperature variation of less than $\pm 0.2^{\circ}\text{C}$, a minimum of 2 inches (50mm) must be allowed between the rear and sides of the Incubator and any walls, partitions or obstructions to facilitate adequate convection of air around the Incubator. Confirm clearance with a tape measure if needed. Adjust the Incubator location accordingly. In addition, the Incubator location should address access to its power cord for connection/disconnection if necessary. For maintenance and service purposes, the control center electronics should remain accessible. Leave at least 3 ft of clearance in front for the swinging door.

7.2 Leveling

Prior to use the incubator should be leveled using a bubble level on a middle shelf in the chamber. The Incubator should have all 4 leveling feet firmly on the bench or floor. Level from side to side and front to back. By turning the adjustable leveling feet counterclockwise, raises the Incubator.

7.3 Interior Chamber, Shelf & Water Pan preparation.

Chamber & Shelves

The incubator is shipped with the shelves installed. A shelf-mounted water pan is also available. NuAire recommends decontaminating all surfaces within the interior chamber, glass door, and outer door with gasket. They can be wiped down with a disinfectant of 70 percent alcohol or a similar non-corrosive antimicrobial agent. Use only disinfectants that are compatible with the vinyl gasket, the powder coat paint on the outer door and the 304L stainless steel in the chamber. See BCD-19904

NOTE: Absolutely no Chlorinated or Halogen materials are to be used in the chamber.

NuAire does not offer any product warranty with respect to cleaning material compatibility. **USE AT YOUR OWN RISK!** The information provided above is from raw material suppliers and known general source documents for use to develop application cleaning SOP's.

Four (4) shelves are installed in each Incubator. The shelf positions are easily changed by removing the shelf and moving the horizontal guides to the position desired. If the shelf does not bind or disengage from the horizontal bracket it is installed correctly. Additional shelves and shelf guides are available.

Water Pan

Place the water pan in the center on the bottom of the chamber and fill with **Single DISTILLED WATER no purer than 1 Mega Ohm**. It is recommended to fill the pan to a maximum of about 1/2 inch below the top rim. See Sections 3.1 and 8.2 for more specifications and operational details regarding proper maintenance instruction regarding the water.

REV	CO	DESCRIPTION	DATE	DFTR	CHKD
B	002738	UPDATED NOTE	1/8/2024	RN	MSS

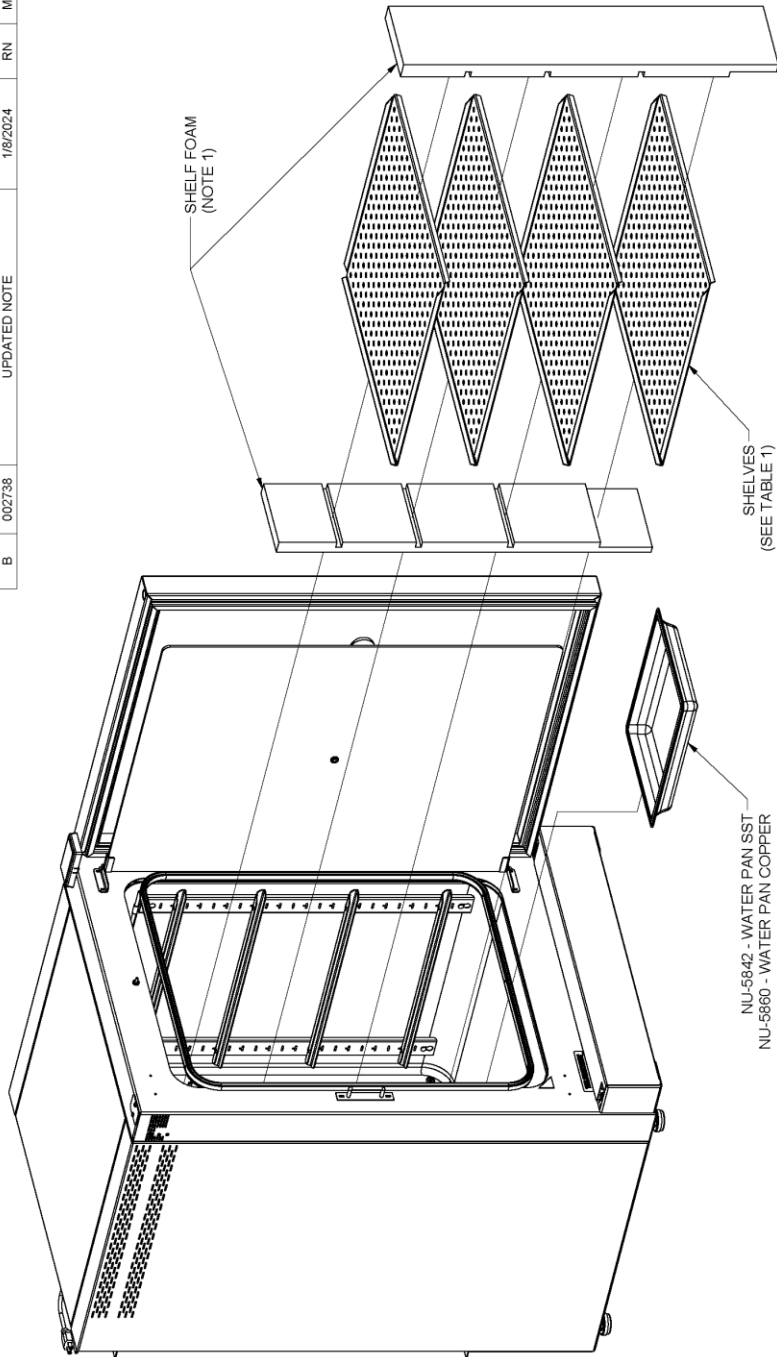

						
TITLE						
DH / D INTERIOR PREP						
DFTR	DATE	CRKD	SHEET	1	OF	1
TH	4/17/2018	KCK				
DRAWING			NUMBER			B
BCD-19904						

MATERIAL	200L	160L
SST	NU-1583	NU-5783
COPPER	NU-1584	NU-5784

NOTES:
1. REMOVE FOAM BEFORE INCUBATOR OPERATION.

7.4 Electrical

The electrical supply circuit to the Incubator must conform to all national and local electrical codes.

Consult the serial-data plate, located at the front of the right side of the Incubator, for voltage, cycle, phase, and ampere requirements before making a connection. Plug the power cord securely into a grounded power source. **VOLTAGE SHOULD NOT VARY MORE THAN 5% FROM SERIAL PLATE RATINGS.** Have a qualified technician check with the power source with a properly rated voltmeter if needed. A separate branch circuit is recommended to prevent possible loss of product due to overloading or failure of other equipment on the same circuit. **A SURGE PROTECTOR IS STRONGLY RECOMMENDED** to avoid power-related faults.

7.5 Air Inlet Connection

The air inlet and filter are installed at the Factory. The filter has a flexible hose that attaches to bulkhead fittings in the bottom of the front panel and can be found under the Valance that is beneath the door. One 50mm polypropylene .3-micron HEPA filter is connected to the hoses. The filter is labeled "Air filter". To open the valance the outer door must be open. Reach in under the valance and the lift is for access. See BCD-18316. The air inlet on the back of the incubator is connected to the filter by a hose at the factory and does not require installation.

CAUTION: This is a free (open air atmospheric) air supply. DO NOT connect to a pressurized air source.

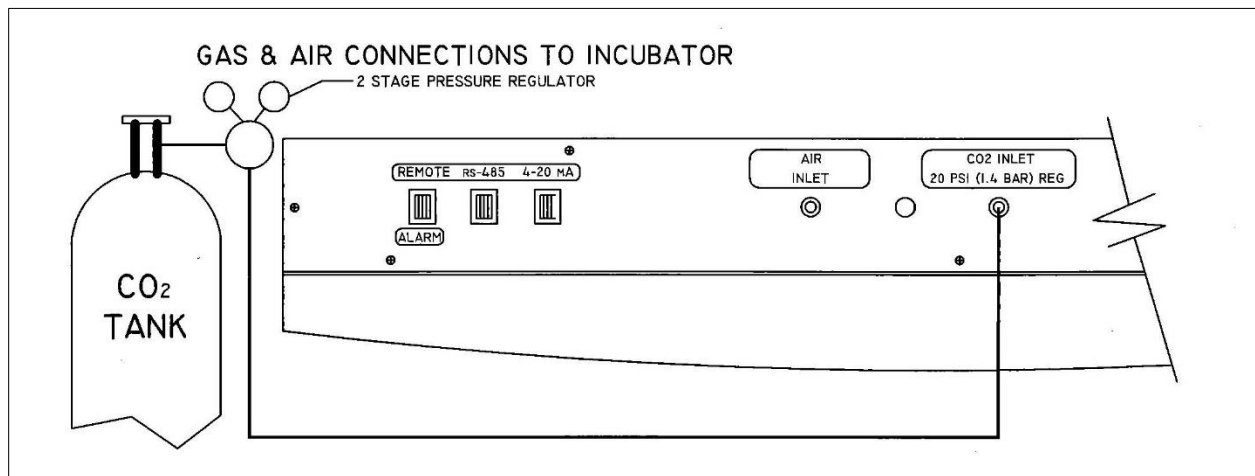

7.6 CO₂ Connection



**High concentrations of CO₂ gas can cause asphyxiation!
Install Incubator in a well-ventilated area.**

This Incubator is designed to be operated with CO₂ gas only. Connecting a flammable or toxic gas can result in a hazardous condition. Gases other than CO₂ should not be connected to this equipment. CO₂ gas cylinders have a UN1013 label on the cylinder and are equipped with a CGA 320 outlet valve. Check the gas cylinder for the proper identification labels.

Do not use CO₂ gas cylinders equipped with siphon tubes. A siphon tube is used to extract liquid CO₂ from the cylinder which can damage the pressure regulator. Consult with your gas supplier to ensure that the CO₂ cylinder does not contain a siphon tube.

7.6.1 Gas and Air supply HEPA filtering is installed at the factory on the front of the incubator as illustrated in the picture. Each incubator is equipped with the filters required for the control systems available on that model.



7.6.2 CO₂ Tube Connection

Included with the Incubator is a tubing kit consisting of (1) six-foot (2m) vinyl tube. Hook one end the six-foot tube to the fitting labeled CO₂ (20 psi) on the back component panel of the incubator. Then hook the other end on the outlet of the 2-stage regulator located on the gas supply. You can locate the CO₂ supply filter on bottom right of the front panel behind the valance at the bottom of the outer door. The filter is labeled CO₂ filter. To remove the valance the outer door must be open. Please see the Maintenance section for the proper period to change the filter.

7.6.3 CO₂ Supply

- CO₂ of medical grade is recommended.
- A two-stage pressure regulator, Linde # 19590, or equal, is recommended.
- DO NOT USE a single stage regulator.
It will not give a stable output at 20 psi and exposes the Incubator to the gas cylinder pressure.

7.6.4 CO₂ Regulators

The regulator's high-pressure stage direct from the supply cylinder must have a range of from 0 to 2000 PSI or 0 to 140 BAR. This gauge indicates actual tank pressure. The low-pressure stage should have a range of 0 to 30 PSI or 0 to 2 BAR (100 PSI or 6 BARS maximum). This gauge will indicate the actual CO₂ pressure to the Incubator. Some single stage CO₂ pressure regulators have two gauges. **USE A TWO-STAGE REGULATOR.** All NuAire Incubators use CO₂ in such small quantities that precise metering of CO₂ input pressure is important for maximum performance.

To connect the regulator:

- First:** Open the CO₂ cylinder slightly, for an instant (this is termed "cracking the valve.")
This will blow out dust or dirt that may have collected in the valve outlet.
BE SURE to keep your face away from the valve outlet to protect your eyes from dust or dirt.
- Second:** Make sure the regulator pressure-adjusting screw is released by turning it counterclockwise until it turns freely.
- Third:** Attach the regulator to the cylinder valve and tighten the connection nut with a wrench.
BE SURE DISC SEAL IS IN PLACE BEFORE MAKING CONNECTION.

7.6.5 CO₂ Connection

Connect the CO₂ supply from the low-stage of the two-stage regulator to the inlet fitting located on the Incubator back panel labeled "CO₂ tank 1". The filter should be inserted downstream of the low-stage regulator before the inlet fitting on the Incubator as shown in the figure. Secure each connection with the clamps supplied. Observe proper flow orientation of the filter (look for "in" or a green dot on the filter). The tubing is easily cut with a sharp knife.

7.6.6 CO₂ Supply Adjustment

With the regulator OFF (i.e. fully counterclockwise), open the cylinder valve slowly, usually 1 to 2 turns is sufficient.

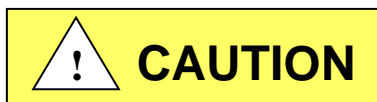

NEVER STAND IN FRONT OR BEHIND THE REGULATOR WHEN OPENING THE VALVE. ALWAYS STAND TO ONE SIDE.

The cylinder tank pressure should read 700 to 800 PSI or 48 to 55 BAR, more or less, depending on the temperature of the cylinder. Next, turn the regulator's pressure adjusting screw clockwise, until the low-pressure gauge reads 20 PSI or 1.4 BAR. The CO₂ connection is now complete.

NOTE: OSHA requires the CO₂ tanks to be physically restrained (i.e. via chained to wall) to prevent accidental damage to cylinder.

7.6.7 Checking the Connections

The connections can be checked for leakage by brushing a small amount of soapy water on each one. Observe to see if any bubbles are blown. If not, the connection is secured properly. If it is, the cause of the leaking needs to be determined, (i.e. loose clamp or damaged hose) and corrected.

7.7 Remove the cable tie used to secure the air pump for shipping:

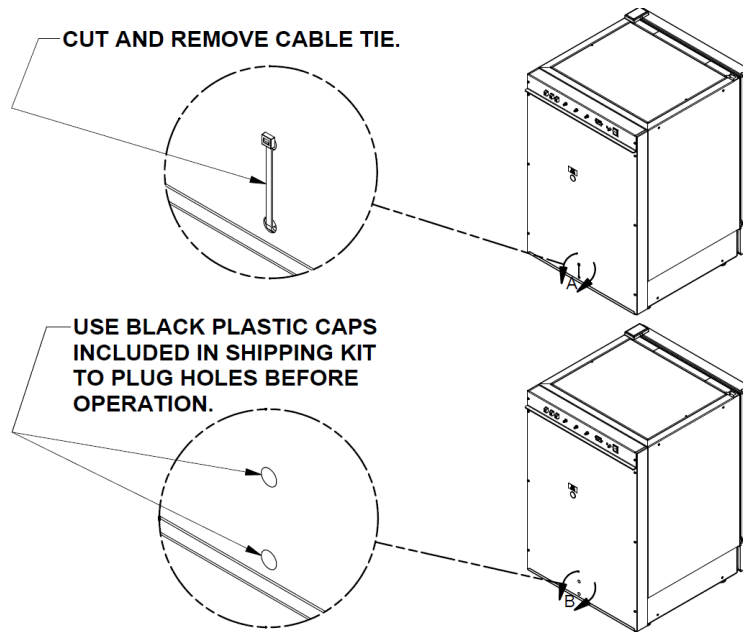

7.8 Setting up the access port:

When utilizing the access port do not block or restrict the relief holes in the center of the port plug. Blocking this venting can cause performance issues for the incubator. Cut slits or new holes in the vented plug to make passage for cables or other items requiring access to the chamber if needed.

7.9 Correct Installation

When the Incubator is installed correctly connected to the power source it is rated for gas connections made properly, the water pan filled, the shelves in place, and the unit is leveled. Read section 8 and follow all instructions for setting set points at the desired value. Then calibrate the Incubator control systems as explained in section 9. If the Incubator is installed and calibrated correctly it will meet the performance specs listed in section 3.2.

7.10 Reversing Incubator Hinges

Reversing the incubator hinges from the right to the left side SEE PTB0236 for instructions. This requires disassembly of the incubator and should be done by a qualified service technician.

8.0 DH Operation



ATTENTION ACCOMPANY'S INFORMATION OR IMPORTANT SYMBOL

191



POTENTIAL ELECTRICAL HAZARD ONLY QUALIFIED PERSON TO ACCESS

188



HOT SURFACE BURN

564

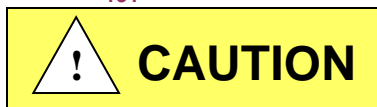

Safety alert symbol indicates potentially hazardous Situation which, if not avoided, may result in minor Or Moderate injury.

CAUTION: A qualified technician who is familiar with the proper maintenance procedures required for this equipment, as well as repair must perform all maintenance actions on this equipment.

The Incubator is designed to provide a sterile, constant temperature, constant CO₂ level and naturally humidified atmosphere for optimum growth of tissue cell cultures and other organisms requiring this precise environment. To operate the Incubator properly, the following parameters must be reviewed, carefully set, and/or prepared.

8.1 Sterility

The chamber environment is not selective. The growth environment is applied equally to all microorganisms (specimens and contaminants) within the chamber. Therefore, before placing any cultures in the Incubator, the shelves and sidewall top plenums should be sterilized. The interior sidewalls, top, bottom, door, as well as the gasket should be wiped clean with a 70% solution of isopropyl alcohol or other disinfectant compatible with the chamber construction, to remove any contamination. Use mild detergent to clean the exterior of the Incubator.

NOTE: NuAire does not offer any product warranty with respect to cleaning material compatibility. USE AT YOUR OWN RISK! The information provided above is from raw material suppliers and known general source documents for use to develop application cleaning SOP's.

8.2 Humidity

Humidification of the Incubator chamber is achieved through the process of water evaporation (vapor water pressure) from a stainless-steel water pan placed on the bottom of the chamber. Materials of different thermal resistance (e.g., glass, plastic) do not offer sufficient thermal recovery and are not recommended for water pan usage. Although some metals offer better thermal coefficients than stainless steel, dissimilar metals cause electrolysis in the acid atmosphere (carbonic acid) and should never be used or placed within the chamber.

Use only distilled or mineral-free water, no purer than 1 megaohm, in the stainless-steel pan. The water should be changed at least once a week. **FLOODING THE BOTTOM OF THE INCUBATOR IS NOT RECOMMENDED** since it is difficult to change the water weekly and almost always necessitates the use of chemicals, which are not recommended and may damage the stainless steel. Also, it promotes condensation on the inner walls because it steals the natural convection, heat flow through the inner chamber and condensation points occur.

NOTE: ABSOLUTELY NO CHLORINATED OR HALOGEN MATERIALS ARE TO BE USED IN THE CHAMBER.

Humidity recovery to 90% of the original level will occur in 20-40 minutes on average after a 15-second door opening with a water pan surface area of 120 square inches (774.2 sq. cm). Contamination in the water pan may be avoided by adding a small amount of copper sulfate to the water pan after each Incubator decontamination.

NOTE: Please contact the copper sulfate manufacturer to determine the proper amount of copper sulfate that should be added to the water pan.

Condensation on the glass door, walls, top, or bottom of the chamber indicates an incorrect balance of door and front perimeter heat. Both the door and front perimeter heaters operate on a duty cycle. A good starting point for these duty cycles is the default setting for the door & perimeter heaters in a room ambient temp of 22°C (72°F) at a temperature set point of 37.0°C. The fresh airflow that the air pump delivers to the chamber has been preset at the factory. If condensation starts forming on the sides or back wall in the chamber, the number and length of air injections into the chamber can be increased. (See section 9.3 for instructions.) To alleviate the condensation, increase the airflow. To increase RH in the chamber, reduce the airflow. If airflow is decreased, some condensation may be unavoidable. The port plug with breather holes must be used on the side port.

**NOTE: DO NOT SEAL OR RESTRICT THE OPENING IN THE PORT PLUG.
THIS IS A PRESSURE RELIEF FOR THE CHAMBER.**

8.3 Control System Introduction

The NuAire Incubator Control Electronics system is designed to serve the control requirements of the Incubator chamber. Temperature and CO₂ levels are controlled by preset values to provide the optimum conditions for culture growth within a chamber. Operator input is coordinated through the *NU-TOUCH* LCD keypad and status displays. Figure 1 shows the various inputs and outputs of the system.

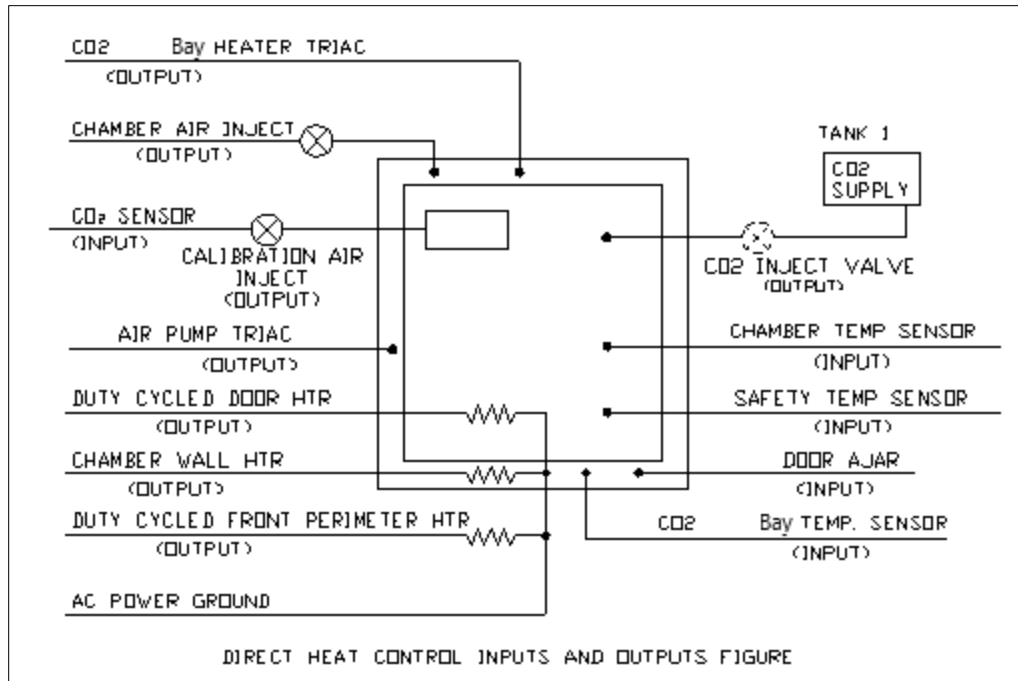

The NuAire Incubator Control Electronics is a state-of-the-art microcomputer-based system that provides:

8.3.1 Chamber control in a single electronic package.

8.3.2 Enhanced information presentation on a Nu-Touch LCD

Main Screen Continuously displays:

- Measured Chamber Temperature
- Measured CO₂ level in the chamber
- Current Screen ID "MAIN SCREEN"
- A mode status indicator (RUN, STANDBY or Power loss recovery)
- NuAire Logo button Leads to the System settings menu when pressed
- Date and Time
- Air, CO₂ inject, door ajar status displays
- An Alarm Status Menu

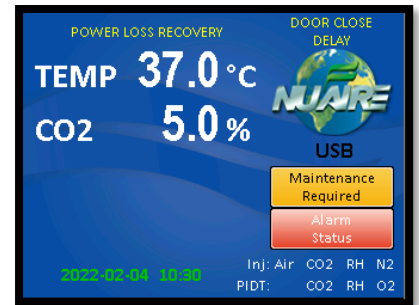

8.3.3 Active buttons on the MAIN SCREEN:

Button Description	Action when touched
Control system description (i.e..... TEMP or CO ₂)	Brings a pop-up screen that describes the control system that was touched
Measured value of each control system	Goes to the Environmental Set Point Screen (Keypad to enter the password will pop up if the password function is enabled)
NuAire Logo	Goes to "System Settings" Screen
Date & time display	Goes to screen for adjusting time and date

8.3.4 Accessing the Incubator Control Screens

Accessing the many Control screens, performing functions and diagnostic tests, and maneuvering through the NU-Touch LCD menu system is accomplished through the following methods:

- Touching a "graphic" Icon like the NuAire Logo in the Main Screen which accesses the System Settings menu or lead you to an Enter Password screen when a password has been established.

- Touching a “Button function” button command that is visible on the screen. The button will have text in it indicating the function you are about to perform.

The following buttons are used on the NU-5700:



An explanation of these buttons is as follows:

- Save** - This command saves the changes you have made and returns you to the calling screen or, in some cases, back to the main menu.
- Exit** - This command exits you from the current screen and returns you to the calling screen.
- Close** - The command causes the current screen to be removed and returns to the calling screen.
- Back** - This command returns you to the previous screen.
- Start** - This command causes a main event to begin.
- Next** - This command causes another step (screen), in a list of steps (screens) to be displayed. (e.g., CO₂ calibration screens).

- Cancel** - This command will cancel the changes you have made, and in some circumstances, cancels the “set of requests” that you have entered and returns you back to the calling screen.

- Touching a “Text” button command. The text or numerical value will be in blue indicating that is a link similar to the computer or on the internet. The system settings menu screen shown below is a good example of both the Text commands and Button commands:

NOTE: The Main Screen is the one exception for the above-described buttons. The green clock text is and is a link to adjusting the time. The large white Control system measured values are also a “second” link to the “Environmental Set-Points” menu and the control system descriptions are a link to system description pop-up screens when touched.

Functioning accessed from the System Settings screen:

The “System Settings” menu screen can be accessed from the “Main Screen” by touching the NUAIRE logo:

Environmental Set-Points: Allows adjustment of Temperature, CO₂, Door, and Perimeter heater power level settings.

NOTE: You can also access the Environmental set points by touching any control system numerical value in the MAIN SCREEN.

- Performance Monitor:** Views a function’s Set-Point and Measured values over the last seven days.
- Service Settings:** Protected by the password 9876, it facilitates Calibrations, Option settings, and access to Diagnostics.
- System Information:** Views the units Model Number, Serial Number, Control board assembly (CCBA) Software Revision and the Display board assembly (LCBA) Software Revision.
- Display Settings:**
 - Brightness:** Allows adjustment of the screen brightness. Slide right to increase / left to decrease.
 - Calibrate:** Press button to access screen calibration - follow screen prompts / target symbols.
 - Save:** Remember to press the “Save” button after making changes or calibrating the screen. They will be lost if “Cancel” is pressed to exit the screen.

Set Password: A 4-digit password can be set and will protect access to Environmental Set points, and changing the password

System Settings Screen



8.3.5 Automatic notification of abnormal situations (See Section 11 for more detail)

The red “Alarm Status” text message (button) will appear on the Main Screen to indicate a fault within the Incubator system. An audible alarm is also heard. The audible alarm is on for 10 seconds at the beginning of an alarm condition and thereafter, it will be on 1 second every 30 seconds.

By depressing (touching) the Alarm Status text on the Main Screen, you now reach the Incubator Alarm Status screen which will identify which Incubator sub-systems are in an alarm state (Temperature, CO₂, or General). You may exit the screen or touch any of the sub-system buttons which will give you more specific information on alarm conditions. See Section 11.0 for more specifics on alarm conditions.

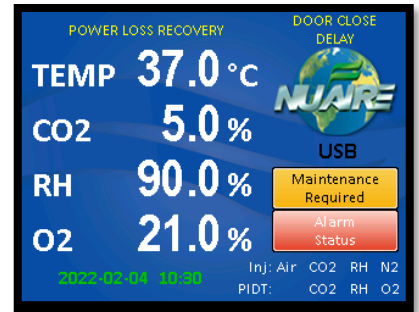

8.3.6 Password Protection

There are 2 levels of password protection.

1. The permanent numerical password required for accessing the “Service Settings” menu screen.

This screen is accessed by pressing the “Service Settings” text Icon in the “System Settings” menu screen.

The password is **9 8 7 6** and it cannot be changed or deleted.

The functions in the “Service Settings” screen are intended to be used by qualified technicians to calibrate the control system sensors like Temperature and CO₂, adjust optional parameter settings to customize incubator performance, perform system diagnostics and to Factory or Master reset for returning the incubator to Default settings.

2. A selectable 4-digit numerical password that is entered by the Incubator user to prevent others that are not authorized to change the Incubator set points (CO₂%, Temp), running conditions of the Incubator, or changing passwords. The password protection may be initiated by accessing the “Set Password” menu in the System Settings menu screen. Once initiated, a four-digit number must be entered, then re-entered for verification.

8.3.7 Standard remote communication capability

The Incubator comes equipped with the following remote communication tools:

- USB Output of daily, weekly & monthly performance logs and an event log that indicates when alarms, door openings and power interruptions occur.
- 4-20 milliamp analog Output
- RS-485 2-way communications
- A USB method of updating the software.

8.3.8 Diagnostic and calibration assists.

To access the Service Settings Menu, perform the following steps: NuAire Logo → Service Settings → 9876 Enter. You are now in the Service Settings Menu (screen). This screen provides you the capability to review and analyze numerous Incubator functions including the following:

- Individual analog inputs may be displayed to assist calibration.
- Individual outputs may be forced to an on or off condition.
- Individual digital inputs may be displayed.
- Calibrated and Uncalibrated values are displayed. All options may be individually tested.

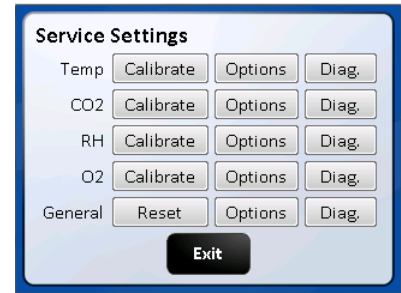

8.4 Front LCD NU-Touch screen Descriptions

The system LCD touch screen has the following functions.

8.4.1 Front LCD touch screen Descriptions

The NU-TOUCH LCD allows the user to access a wide variety of unit configurations and diagnostic menus by touching the NuAire logo icon.

The Main Screen displays:

- Power Interrupted message displayed when power is lost and then restored.
- Current Calibrated values of control systems that have been enabled.
- Current operating mode (run, standby or Power Loss Recovery)
- Door Ajar, Alarms, and Maintenance notices

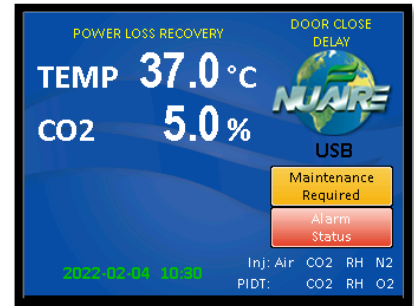

8.4.2 Inject CO₂ Status

On the bottom right of 'Main' screen, "CO₂" text indicates when the CO₂ control valve is open, and CO₂ is flowing into the chamber, the system is injecting CO₂ to maintain the set point.

8.4.3 Post Inject Delay Time (PIDT)

On the bottom right of the 'Main' screen just below the inject status icons from 8.4.2, "CO₂" text indicates when these systems are in post-inject time after the injection is done.

NOTE: Each text icon appears independently when that system is in the delay time.

8.4.4 Inject Air Status

On the bottom right of the Main screen "Air" text indicates that fresh air is currently being injected into the chamber.

8.4.5 Door Ajar Status

The door ajar white text message indicates when the inner glass door is not closed and latched; the inner glass door is open. The door ajar status is a result of the pressure switch (open/closed) located along the top middle of the front panel. After the door is closed, the text will display "Door Closed Delay" indicating the delay time (60 sec adjustable).

8.4.6 Power interruption notice

Indicates that the power has been interrupted. Touch text to acknowledge and NuAire Logo will reappear.

8.4.7 USB status

The USB status icon appears in the lower right side of the Main screen when a memory stick is placed in the USB port to the right of the NuTouch display while downloading performance and event history. This icon disappears when the memory stick is removed from the port.

CAUTION: When a memory stick is placed in the USB port it can interfere with the RS-485 communication output. The RS-485 communication may have to be restarted after the memory stick is removed from the port.

8.4.8 Power Interruption Notification

Indicates when a power interruption has occurred. This can be a power outage or turning the incubator off then on again. Responding by touching the text will bring the NuAire Logo back.

8.4.9 Alarm Status Notice

The “Alarm Status” button is triggered when a timer for a maintenance reminder runs to zero. This text appears in red just below the NuAire Logo (section 8.4.1). The “Alarm Status” button and audible alarm indicates the abnormality. A catastrophic temperature control condition will de-energize the safety relay and cause the chamber to cool below the set point. The unit will resume heating when it has recovered from the abnormality. See section 8.3.5 and 11.0 for more details on Alarms.

8.4.10 Maintenance Required Notice

The “Maintenance Required” button indicates that a check for maintenance should be done. This text appears just above the AIR CO₂ status messages (paragraph 8.4.2 and 8.4.3). This is a visual alert, only no alarm will sound. Press the “Maintenance Required” button to go to the screen that will tell you what maintenance should be performed. See section 10 for more detailed information regarding this Notice.

8.5 Rear Panel Detail

The rear control panel contains the following functions.

8.5.1 Power Cord

The power cord is 6.5-foot (2 m) in length, type “SVT” molded plug, allowing for long life and easy cleaning.

8.5.2 Circuit Breaker

All control electronics are protected with a circuit breaker that may trip at 110% of load rating but will trip at 145% of load rating in less than 2 seconds.

NOTE: Should the circuit breaker open (pop-out button will appear), merely depress to reset.

8.5.3 CO₂ Inlet All models

The CO₂ inlet provides a fitting for vinyl tubing.

Be sure to follow the recommended inlet pressure to ensure proper flow rates and consistent CO₂ percentage readings.

8.5.4 Power Switch

The power switch, located at the top of the rear panel, controls all power to the Incubator.

8.5.5 Communication Interface/Alarm

Three receptacle connectors are provided for direct field connection of a computer for 2-way communications and incubator monitoring/or output to a printer or other device only capable of receiving RS-485 digital information, dry contact remote alarm indicator, also 4 to 20 mA output to an analog monitoring device or system.

8.5.6 Air Inlet

This is a free air supply.

DO NOT CONNECT TO A PRESSURIZED SOURCE.

Air filter is installed at the factory on the front of the unit.

REV	CO	DESCRIPTION	DATE	DFTR	CHKD
D	002738	REMOVED PART NUMBERS	1/5/2024	RN	CI

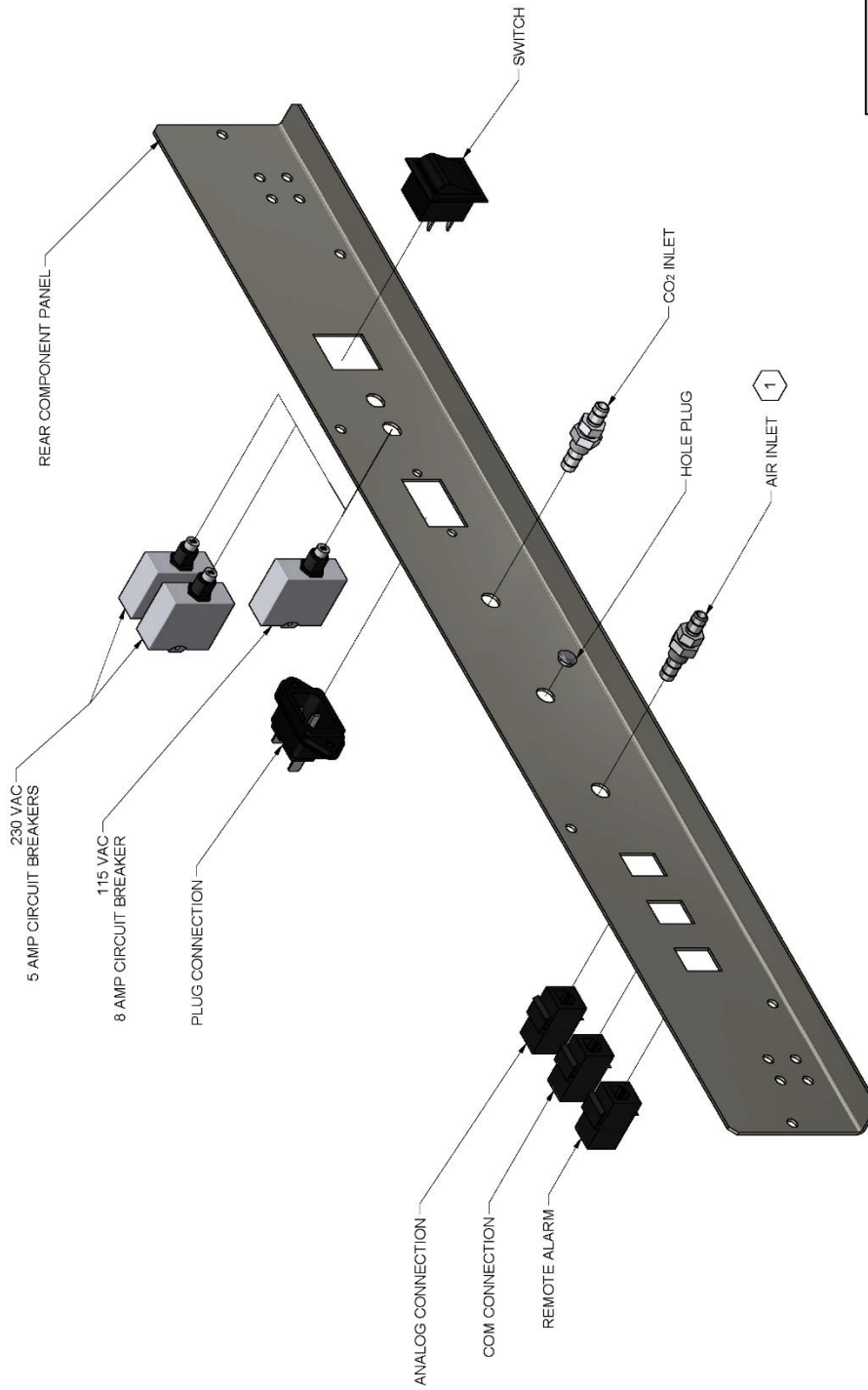

REAR PANEL ASSEMBLY NUJ-5800						
DFTR	DATE	CRKD	SHEET	1	OF	1
AW		10/15/2012		KCK		
DRAWING NUMBER			BCD-15669			
			D			

NOTES:
 1 AIR FILTER INSTALLED AT FACTORY ON FRONT OF INCUBATOR.

8.6 Front Component Panel

The front component panel contains the following functions.

8.6.1 CO₂ Supply Filter

The CO₂ supply filter is installed at the factory and should be changed following the instructions found in Maintenance Section 10.

8.6.2 Air Inlet Filter - All models

The Air Inlet Filter is installed at the factory and should be changed following the instructions found in Maintenance section 10. This is a free air supply.

NOTE: DO NOT CONNECT TO A PRESSURIZED SOURCE.

8.6.3 Chamber sample port

The Sample port is provided for checking the CO₂ level in the chamber to monitor the calibration of the Sensor and determine if it needs adjustment. It is located in the middle of the inner glass door.

8.6.4 Sensor Bay access panel

Provides access to the CO₂ sensor, Capsule Filter, and the Hydrophobic filter for maintenance.

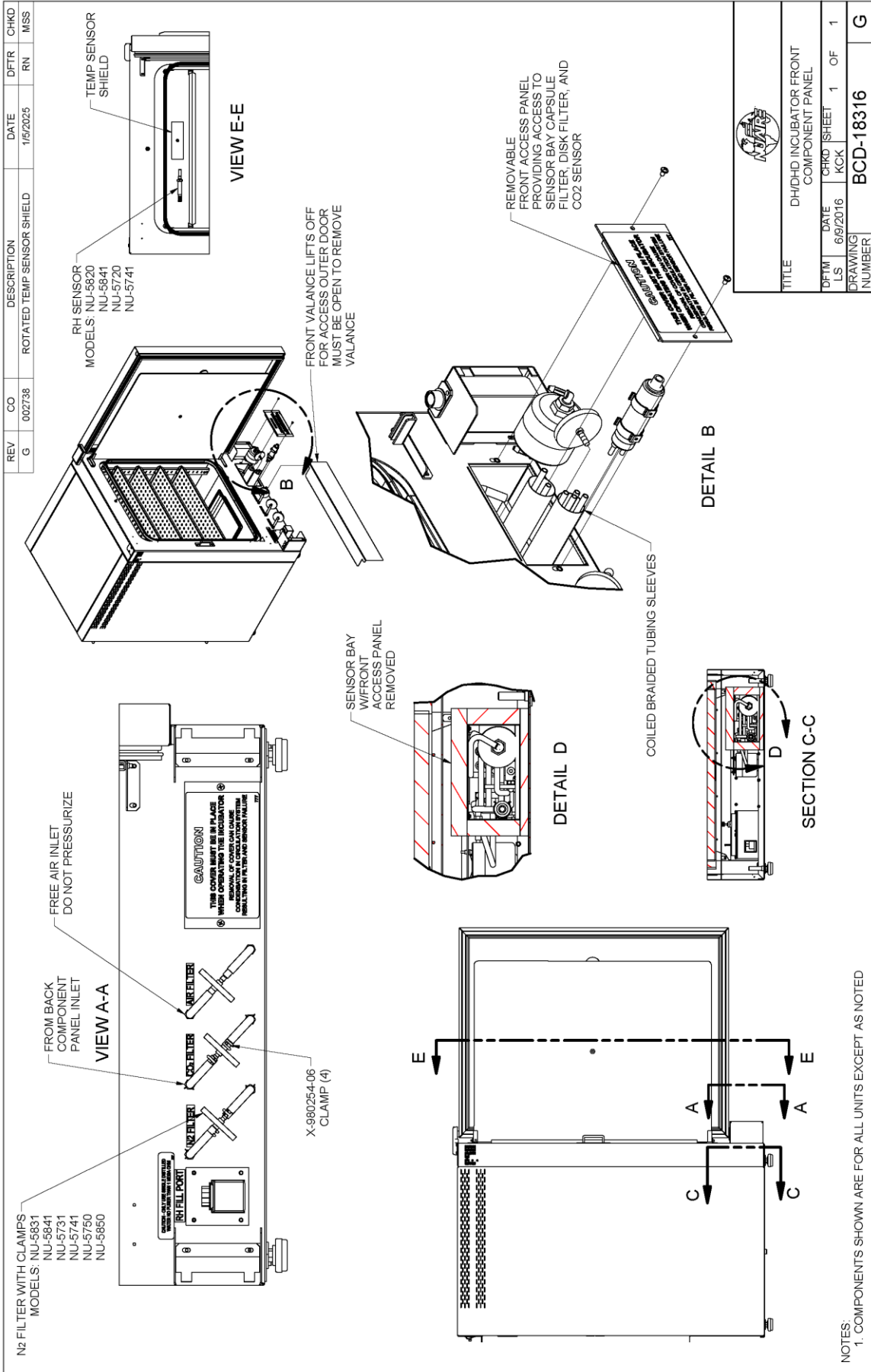

NOTES:
1. COMPONENTS SHOWN ARE FOR ALL UNITS EXCEPT AS NOTED

8.7 Run Mode Operator Interactions

8.7.1 THE FIRST TIME THE INCUBATOR IS TURNED ON

- The NU-Touch boot up screen appears then shows a screen instructing you to “Read the manual and follow all instructions to properly install the incubator” Both screens will automatically advance after 5 minutes. To manually advance:
 - Press the exit button then a thank you screen will appear.
 - Press the “Continue” button then the unit will go to the “MAIN SCREEN”.These screens will not show again unless you “MASTER RESET” the incubator control board.
- Setting the Clock

8.7.1.1 Clock display organization:

YYYY-MM-DD HR: Min and is displayed in green text in the lower left of the display screen.

8.7.1.2 Press the green text and the Time and date adjustment screen appears.

After a power interruption the date and time will flash as follows:

- Green text indicates there was a power interruption, but the real time clock remained powered. Press the flashing text to bring up the “set the clock” screen. If no change is needed press cancel to go back to the main screen. Otherwise, make the required changes then, press the save button to save the changes and return to the main screen.
- Yellow text indicates the real-time clock lost the backup power and the date and time need to be reset. Press the flashing text to bring up the date/time setting screen.

8.7.1.3 Use the up/down arrows to increase or decrease the highlighted value.

Use the left/right arrows to move between date and time values that require changing.

8.7.1.4 Press “Save” to save the changes you just made or

Press “Cancel” to abort the changes and return to the main screen.

The mode display, on the ‘Main’ screen, is used to identify the mode of chamber operation: either standby or run.

In general, there is no need for operator interaction in "run" mode. However, operator interaction is required when the incubator is first turned on, then to perform calibration functions and address abnormal conditions status. If an abnormal condition has, or does, exist for a particular parameter, an alarm becomes active and the ‘Alarm Status’ button will appear. This could be a catastrophic alarm condition, which could harm the tissue culture cells. It does indicate an operational abnormality and should be checked. To acknowledge the abnormality, simply press the “Alarm Status’ button to view the alarm, to dismiss it press the corresponding alarm’s button. The audio and visual alarms will then extinguish. If the abnormality still exists, the return after waiting the specified alarm time.

Let the Incubator run normally, and if the alarm doesn't come back on, then everything is normal. If the alarm does come back on, use the troubleshooting guide to correct the abnormality (see Section 11.0).

8.8 Standby Mode Operator Interactions

The NuAire incubator automatically enters the standby mode when necessary. There is no action required by the user to enter this mode. All functions that put the incubator in standby mode automatically start a 1minute timer. If the function is not interfaced through the screen on the NU-Touch display of the incubator, then it returns to the MAIN SCREEN and switches to RUN mode.

8.8.1 Chamber Temperature, CO₂%, Set- Points

8.8.1.1 Accessing the Environmental Set point screen used to manage set points is done one of two ways:

- Press any control system value displayed in the main screen.
- Press the NuAire logo then press the Environmental Set Point text in the Systems Setting screen.

8.8.1.2 Pressing the blue numerical value next to the control system that you intend to change will bring up a number keypad. Punch in the new value and hit the “enter” key to leave the keypad and return to the Set-point screen. You will be asked if you want to save the new set point(s) when you press Exit to leave the set point screen and return to the Main screen. Press “Save” to retain the changes. Default Set points:

Temperature 37.0 C
CO₂ 5.0%

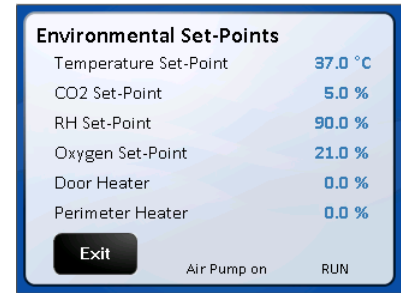

NOTE: A set point of 0 (zero) will put the system into an idle state where it does not control, and all alarms are inhibited. The sensor remains active and reports the level of gas in the chamber.

8.9 Diagnostic and Checkout Procedures

The Incubator controller provides general diagnostic facilities:

- Diagnostic mode is intended for factory and field technicians. It allows them to turn the controller's output signals (heaters, valves, safety devices etc.) on and off.
- Diagnostics are located in the “Service Settings” menu categorized by the control systems (i.e. Temperature, CO₂, RH and O₂) plus a general category for diagnostics not directly related to the control systems. Press the “Diag” button to access them.
- Each screen and the function buttons in them initiate a 5-minute timer. When the timer runs out the display will exit that screen and go back to the main screen. Manually exiting the diagnostic screen will automatically stop that timer and return to the Service Settings screen. The function button that was activated will return the function to the default diagnostic condition at the end of the 5-minute timer. Manually putting the button back to the default condition will reset and stop the timer.

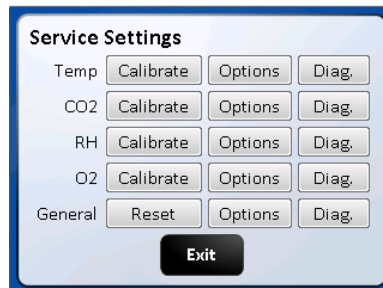

8.9.1 Diagnostic Mode

The diagnostic mode allows the operator to configure and/or check the Incubator for input/output signals manually and individually.

To initiate the diagnostic mode, perform the following from the ‘Main’ screen:

- Select the NuAire Logo to enter “System Settings.”
- Select “Service Settings” and enter 9876, and then hit enter (ENT)
- In the Service Settings menu, select the “Diagnostics” button for the desired function.

Once entered, the Diagnostics screen will display the calibrated and uncalibrated values of the given function and all related components.

Output/Input Diagnostic Parameter Functions

Temperature

1. Safety Relay (on/off)
2. Chamber Temp. Sensor (shows current temp.)
3. Safety Temp. Sensor (shows current temp.)
4. Chamber heater Triac control (**0** - 50% - 100%)
5. Door Heater Triac control (**0** - 50% - 100 %)
6. Perimeter Heater Triac control (**0** - 50% - 100 %)

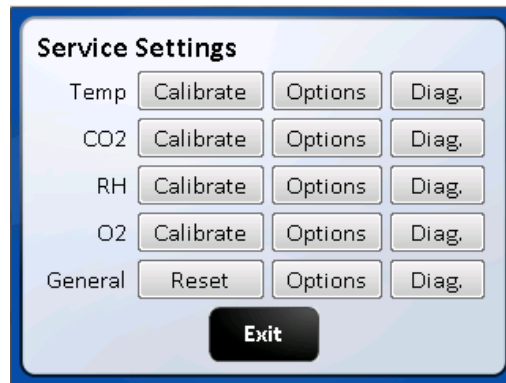

CO₂

1. CO₂ Sensor (Display current CO₂ percentage)
2. CO₂ Inject Valve /on/off
3. CO₂ Sensor Bay Heater Triac (**0** - 50% - 100 %)
4. CO₂ Sensor Bay Temp. Sensor (Displays current temp.)
5. Air Inject Solenoid (on/off)
6. Blocking Solenoid (on/off)

General diagnostics

1. Power Supply Regulated +12 VDC (current voltage)
2. Power Supply Regulated -12 VDC (current voltage)
3. Power Supply Regulated +5 VDC (current voltage)
4. Air Inject Solenoid (on/off)
5. Alarm dry contact Relay (NO/C/NC) switch states
6. Air Pump Triac (on/off)
7. Spare AC Triac

(NOTE: Default values are in **bold**)

The following paragraphs provide a more complete description of the diagnostics listed above.

Temperature Control Diagnostics

1. Safety Relay

This function shows the current state of the safety relay. LCD display will show "On" or "Off" corresponding to the relay condition. On for closed or set or yes.

2. Chamber Temperature Sensor

This function shows on LCD the current values, calibrated (displayed) and not calibrated of the temperature sensor controlling the chamber temperature.

3. Safety Temperature Sensor

This function shows on LCD the current values, calibrated, and not calibrated of the Safety temperature sensor located in the chamber.

4. Chamber Heater Triac Control (0%, 50%, and 100%)

This function allows the chamber heater to be turned on at different percentages 0, 50,100)

5. Door Heater

This function shows on LCD the current state of the door heater. This function also allows the door heater to be turned on at different percentages (0, 50, and 100 percent). The LCD display will show phase firing percentage chosen default is 0%.

6. Perimeter Heater

This function shows the current state of the perimeter heater. This function also allows the perimeter heater to be turned on at different percentages (0, 50, and 100 percent). The LCD display will indicate percentage of phase firing chosen default is 0%.

CO₂ Control Diagnostics

1. CO₂ Sensor

This function shows the current CO₂ sensor reading.

The value comes in as a ppm number which can then be easily displayed as a percentage number.

2. CO₂ Inject Valve

This function shows on LCD the current state of the CO₂ inject valve. LCD will show "ON" or "OFF" corresponding to the valve condition. On for open or set or yes.

3. CO₂ Sensor Bay Heater Triac Condition

This function shows on LCD the current state of the CO₂ Heater triac. LCD will show 0, 50, and 100 percent corresponding to the relay position.

The triac can be toggled to each percent of phase firing manually.

4. CO₂ Sensor Bay Temperature Sensor

This sensor shows the sensor bay temperature in degrees C.

Temperature is controlled to temp set point +3.5 degrees.

5. Air inject Solenoid

This function shows on LCD the current state of the Air Inject Solenoid.

LCD will show "ON" or "OFF" corresponding to the solenoid position.

Default is off solenoid activates when the button is touched.

6. Blocking Solenoid

This function shows on LCD the current state of the Blocking Solenoid.

Default is off – solenoid activates when the button is touched.

General Control Diagnostics

1. Power Supply Regulated +12 VDC

This function will display on the LCD screen the current value (+12.xx) of the regulated +12 VDC power supply.

2. Power Supply Regulated -12 VDC

This function will display on the LED screen the current value (-12xx) of the regulated -12VDC power supply.

3. Power Supply Regulated +5 VDC

This function will display on LCD screen the current value (+5.00) of the regulated +5 VDC power supply.

4. Chamber Air Inject Solenoid

This function shows on LCD the current state of the Air Inject Solenoid. LCD will show "ON" or "OFF" corresponding to the solenoid position. Default is off-solenoid activates when the button is touched

5. Remote Alarm Relay

This function shows on LCD the current state of the remote alarm relay. The LCD display will show "ON" or "OFF" corresponding to the relay condition and its Normally Open (NOO pair of contacts

6. Air Pump Triac

This function shows on LCD the current state of the Air Pump Triac. LCD will show "ON" or "OFF" corresponding to the relay position. The triac can be manually turned On and Off.

Option Configuration Parameters

Format: Option (**Default**, Minimum/Maximum)

All the options for the NU-5700 Incubator use the same format. The default is set at the factory and can be restored in the field with a Master, or a Factory reset command. On the following pages, there is a short description of each Option with its Default/Minimum/Maximum setting, followed by a more detailed description.

Temperature

1. Maximum Above Set Point (**1.0° C**, .1/10.0)
2. Temp Low Time Out Timer (**240 minutes**, 0/300)
3. Minimum Below Set Point (**0.5° C**, .1/10.0)
4. Sensor Differential (**4.0° C**, 0/10)
5. Recovery Delay Time (**60 seconds**, 0/120)

1. CO₂CO₂ System Enable (**On**, On/Off) (in Settings Screen)
2. Maximum Above Set Point (**1.0%**, .1/10.0)
3. CO₂ Low Time Out Timer (**10 minutes**, 0/240)
4. Min Below Set Point (**0.5%**, .1/10.0)
5. Post Inject Delay Time (**60 seconds**, 0/250)

General

1. Door Close Delay Time (**60 seconds**, 0/300)
2. Air Inject Time (**10 seconds**, 0/100)
3. Air Inject Cycle Time (**1 minute**, 0/120)
4. Digital Output Interval (**0 minute**, 0/120)
5. Door Ajar Alarm Delay (**5 minute**, 1/60)
6. Settings (Text in top left of the screen)

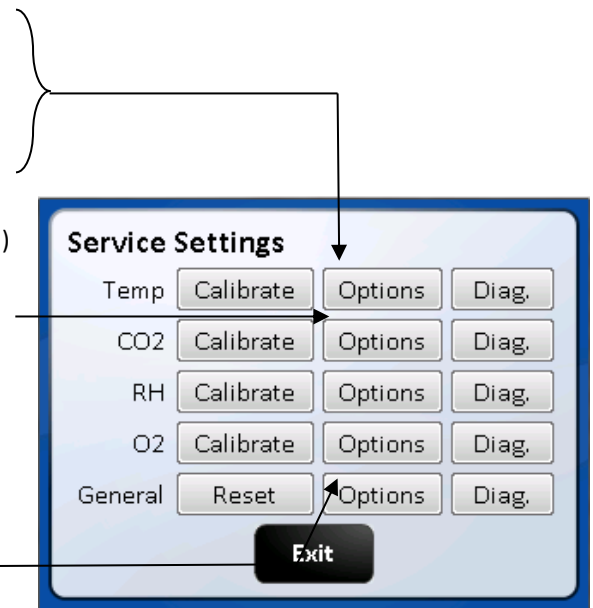

NOTE: Selecting any of the Option title texts will open a brief description of that option's functions.

(NOTE: Default values are in bold)

The following paragraphs provide a more complete description of the diagnostics listed above.

Temperature

1. Maximum Above Set point

This value determines the maximum deviation, measured in (°C) that the chamber is permitted to rise above set point, once it is reached before an alarm condition is declared. An alarm condition will cause the chamber to enter a safe condition where no power is enabled to any of the system output controls until the situation is rectified.

2. Temp Time Out

This value determines the time, in minutes, for the temperature to achieve set point. If the temperature doesn't get to within 0.2° C of the set point within this time period, an alarm condition is declared.

3. Minimum Below Set point

This value determines the maximum deviation, measured in (°C) that the chamber is permitted to fall below set point, once it is reached before an alarm condition is declared.

4. Temp Sensor Differential

This value specifies a maximum differential, measured in temperature (°C) that the two temperature sensors may deviate from one another, or from the last read value. If this differential is exceeded, an alarm condition is declared. An alarm condition will cause the chamber to enter a safe condition where no power is enabled to the chamber heaters until the situation is rectified.

5. Recovery Delay Time

This value determines the time, in seconds, to turn off the chamber heaters in half-degree increments during a temperature recovery cycle. The delay time is required to prevent temperature overshoot of the control set point.

CO₂

1. CO₂ System Enable (Enabled/disabled)

This function will enable or disable the CO₂ system. It is located in the bottom right of the screen. If the system is Enabled, it will be displayed in the MAIN screen. If it is disabled it will not be displayed:

System Enabled (with check mark) means the System is enabled

System Enabled (without check mark) indicates that the system is disabled

2. Maximum Above Set point

This value determines the maximum deviation, measured in (%) that the chamber is permitted to rise above set point, once it is reached before an alarm condition is declared.

3. CO₂ Low Time Out

This value determines the time, in minutes, for the CO₂ percentage to achieve set point. If the CO₂ percentage doesn't get to within its lower limit of set point within this time period, an alarm condition is declared. CO₂ injections are stopped, and air is injected for 15 minutes incase CO₂ was not being detected by the sensor. This alarm can be cleared through the alarm screens or by opening the inner door.

4. Minimum Below Set Point

This value determines the amount in % below the CO₂ set point that the Time out timer will start.

5. Post Inject Delay Time

This value specifies the time, in seconds, for an injection of CO₂ to be measurable at the sensor.

When CO₂ is injected into the chamber, the system delays until this time period has elapsed before making a new control decision. In this manner, diffusion-induced delays do not cause the CO₂ system to overshoot the control set point.

General Options

1. Door close Delay Time

This value determines the time, in seconds, to turn on the door heater to a 50 percent duty cycle after an inner glass door opening. Also inhibits CO₂ control for the same period.

2. Air Inject Time

This value specifies the time, in seconds, for an injection of air into the chamber.

3. Air Inject Cycle Time

This value specifies the amount of time in minutes between each injection of air into the chamber.

4. Digital Output Interval

This parameter specifies the frequency, in minutes that performance and set point data is output to a device such as a printer that is only capable of receiving data.

If the frequency is specified as zero, no data will be output.

5. Door Ajar Alarm Delay

Determines how long in minutes the glass door can be open before an alarm is declared.

7. Settings (top of the screen)

Pressing next button will go to the second page containing the following:

- The Filter Maintenance button to access:
 - Resetting the change filter notice
 - Setting time to a reminder (**48 months**) and disables the feature.
 - View time remaining until current notice is triggered.
- The Clear Password button that clears the 4-digit password that was input through the Set Password screen.
- Change language Button: Pressing this button brings up a screen with the language choices of English (default), Spanish, French & German. Pressing the button in that screen of the language desired will change the user screens to that language.
- Screen Lock button (default Main Screen Unlocked). Pressing this button will change it to "Main screen Locked" (Lockout = 1). This puts a "Press to unlock" button on the NuAire Logo in the Main screen. This feature stops accidental screen changes by brushing the touch screen. You must press and hold (2 seconds) until the message disappears which unlocks the main screen so that you can navigate into; the System settings, Alarms, Environmental Set Point and Clock Adjustment screens.

Pressing the button again will change the text to “Main Screen Unlocked (Lockout = 0). This removes the “Press to Unlock” button from the NuAire Logo and the Main screen goes back to the default condition.

- Power Loss Mode cancel button. Cancels Power loss mode. Only use this if it is certain that there is no condensation in the circulation system. See Section 10.2 for further details about the Power Loss Mode.

8.10 Resetting the Electronics Software

8.10.1 Factory Reset

The Factory Reset is similar to the Master Reset. However, it only changes the Options (returned to default settings) and the environmental set-points (returned to their defaults).

To perform a Factory Reset, you will need to do the following:

NuAire Logo → Service Settings → 9876 Enter → Reset → Factory Reset → Confirm

The Incubator will perform the Factory Reset and return to the Main screen.

8.10.2 Master Reset

The master reset diagnostic function is the last effort to correct operational faults which otherwise cannot be solved. By reloading the default configuration, the entire memory will be reset and ALL CALIBRATION OFFSETS, USER PASSWORD AND CONFIGURATION OPTIONS WILL BE LOST. All calibrations will need to be performed following a master reset.

To perform a Master Reset, you will need to do the following:

NuAire Logo → Service Settings → 9876 Enter → Reset → Master Reset → Confirm

The Incubator will perform the Master Reset then the “Factory Setup” Screen will appear.

The Factory Setup screen shows the Model Number, Serial Number and Language that was chosen for the user screens.

As long as this information is correct you can press Save which will resave the information displayed in the screen then, date and time set screen. If the date and time are correct you can press exit and go to the MAIN screen. If you press Exit you will go to the main screen, however if there is a power cycle the incubator will reboot to the Factory set up screen again. All setup information will show correctly but, you must press save to boot up into the MAIN screen after a power cycle. The model number and the serial number can be verified by comparing them to the serial number label found down behind the valence under the door. The language defaults to English. It can be changed any time through the Service Settings/General/Option/settings menu. See section 8.10 for further instructions.

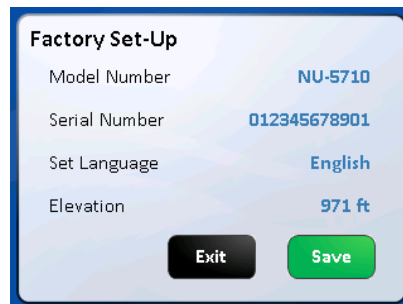

NOTE: After performing either Factory or Master Reset remember to turn the incubator off then on again to ensure that all intended parameters were reset.

8.10.3 Inputting the Factory settings:

The “Factory Set-up” screen will appear after the master reset.

If the Model Number or the Serial Number need to be re-input for any reason the following steps should be taken:

Setting the model number sets the following function:

- Model NU-5700 and NU-5700E
Enables Temperature and CO₂ the only control systems available on this model.
Chooses the algorithm suited for low watt heating of the chamber.
Loads the model number in the System information screen.

- Touch the “Model Number” text then follow the screen prompts as shown below. Pressing continue, the choose Region screen will bring you back to the Factory Set-Up screen showing the Model Number you just entered. Default is NU-5800 if no model number is entered.

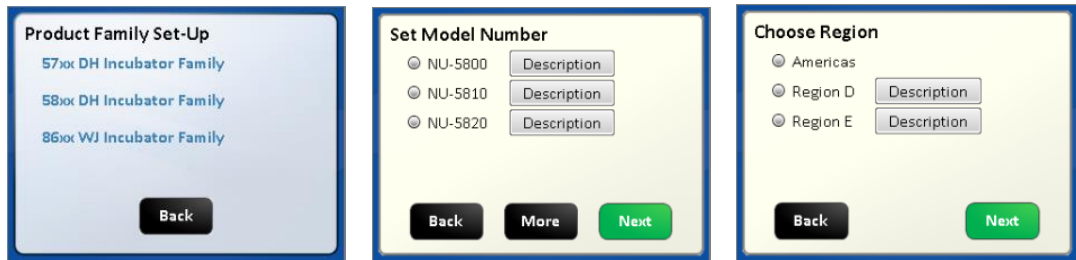

- Touch the Serial Number text then enter the 12 digits serial number which can be found on the serial number label located behind valance under the sample port. Press the ENT button on the keypad screen and you will return to the Factory Set-Up screen showing the serial number you just entered. Default is blank if no number is entered.



- Touch the Set Language text then touch the save button. This sets the language on all of the user screens. The language in the Service Settings menu /screen will remain in English. English is default language if none is chosen. Touch the green save button to exit the factory screen.



- The final change that is requested is the clock. It should not have been reset. As long as the date and time are correct you can cancel out of that screen to the Main screen.
- If the incubator loses power the date/time will flash in green text until it is manually interfaced with. If the date and time are correct you can cancel, and the display will return to the main screen.

When power to the incubator is lost long enough the real-time clock will lose its backup power and the clock will revert to its default time. When power is restored to the incubator the date/time will flash in yellow text and continue until it is reset. Press save to return to the main screen and continue normal operation.

9.0 Calibration

Proper calibration of the incubator involves four parameters: chamber temperature, door temperature, perimeter temperature, and CO₂ sensor. The first three, chamber, door, and perimeter temperature should be completed and stabilized before any CO₂ sensor calibration is performed. Below, each calibration procedure is described in detail. For the best results, follow the procedure carefully, and if the desired result is not achieved, try the procedure again from the start.

9.1 Chamber Temperature Calibration

The DH's TEMPERATURE CALIBRATION MUST BE PERFORMED WITHIN 1°C OF THE PLANNED OPERATING TEMPERATURE. Normally, 37.0°C is the most common set point. To initiate the procedure, turn on the incubator via the power switch on the back panel. The default set point is 37.0°C; enter "Environmental Set Points" and adjust if desired. Let the unit stabilize for 8 to 12 hours. Use an independent calibrated instrument to check and calibrate the temperature.

Below is a description of calibration with a glass thermometer as one example for temperature calibration.

At the beginning of this procedure, set a calibrated glass thermometer in a glass beaker filled with water resting on a shelf in the middle of the chamber. Do not place the glass beaker on the bottom of the chamber because it will result in a slightly higher temperature reading due to the heater located on the chamber bottom. Placing the thermometer in glass beaker on the middle shelf will give the most accurate results for calibration. The chamber should be humidified to avoid false low readings due to evaporation of water from the flask. An accurate digital thermometer with a type K thermocouple could also be used.

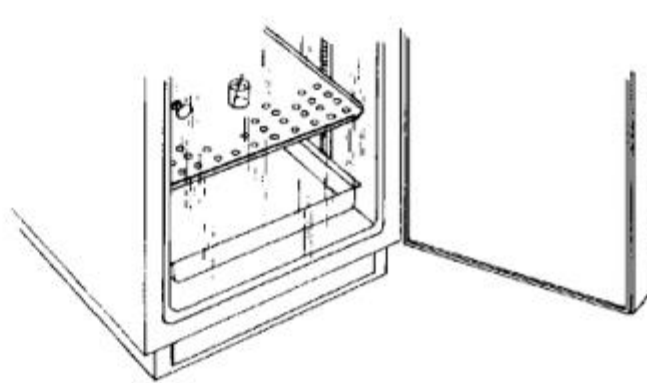

When the unit has stabilized at the operating temperature, perform the following calibration procedure.

- Allow Incubator to stabilize at its given temperature set point in run mode.
- Enter "Service Settings" by means of your provided password.
- Press the Temperature Calibration button.
- Determine actual temperature within chamber by reading temperature measurement instrument.
- Select the number digits below the "Current Calibrated Sensor Reading" blue text button.
- Input the current value displayed on your temperature measurement instrument and exit calibration.

NOTE: THE DISPLAY DOES NOT UPDATE IMMEDIATELY; IT TAKES 2-3 SECONDS

The chamber temperature calibration is complete. Let the unit stabilize for 8 to 12 hours. If the chamber temperature (actual thermometer) still does not match the display, perform the above procedure again. In some cases, it might be necessary to calibrate several times to achieve a stable condition due to ambient conditions of temperature and humidity within the laboratory.

9.2 Door and Perimeter Duty Cycle adjustments for Temperature Calibration

The Door and Perimeter heaters are run on "Base Duty Cycle" calculations that are automatically increased or decreased to run in accordance with the chamber temperature at a chosen set point. These duty cycles work in the controlled lab environment but due to the many variables involved in temperature control there is also a manual adjustment. The heater duty cycles can be adjusted to control condensation or to improve the temperature uniformity in the chamber.

The inner glass door and outer shell perimeter temperature calibration is best accomplished by running the Incubator for a minimum of 24 hours with the water pan in place and perform the following calibration sequence, if required. Open the outer Incubator door and look for general condensation. Some condensation on the glass door can be desirable as an indication of adequate humidity in the chamber. Typically, one to two inches of condensation in the corners of the glass door and/or gasket indicates a properly calibrated door and perimeter heater. The perimeter heater is located on the outer shell next to the glass door gasket. If calibration is required, simply perform the procedure as stated below. As stated earlier the door and perimeter heaters operate on a base duty cycle calculated for the chamber temperature set point being used. In the door and perimeter heater (adjustment) screen "0.0" = the calculated base duty cycle. Adjusting the value up or down will increase or decrease the percent of power to each heater in 0.1% increments. Small adjustments are recommended to a maximum of 5.0% at a time.

The following steps should be taken for setting these duty cycle percentages:

- Allow Incubator to stabilize at its given temperature and humidity level in run mode.
- Enter the “Environmental Set Points” screen either from the MAIN SCREEN or the SYSTEM SETTINGS screen.
- Select the numerical digits following the “Door” or “Perimeter” text. Go to the adjustment screen.
- Press UP or DOWN keys to increase or decrease the numerical value to the desired level. The limits the settings can be changed to are +50 and -20.
- Press “Done” to set current value and exit calibration.
- The reset button for both the door and the perimeter heaters resets the number displayed to 0.0 removing any adjustment previously made.



Adjusting Door and perimeter heater duty cycles to control condensation:

Location of condensation	Adjustment
On the inner glass door	Increase the door heater duty cycle in increments no greater than 5% at a time.
On the inner door gasket	Increase the perimeter heater duty cycle in increments no greater than 5% at a time.
In the back of the chamber	First decrease the door heater in increments of no greater than 5%. If condensation persists and condensation starts forming on the door then move to reducing the perimeter heater in the same manor until condensation stops form.

If condensation persists, see section 9.3 Setting air injections.

9.3 Setting Air Injections

If there is still some undesired condensation in the chamber when the door and perimeter heaters are set for the desired result, the air injections can be adjusted. There is a control for the length of the air injection labeled, Air Inject Time, and the frequency that air is injected called Air Inject Cycle. These controls are described in more detail in the "General Options" section of the Service Settings menu. The default is 10-second injections every 1 minute. Start by increasing the length of the injection by a few seconds at a time then increase the frequency if needed. If the humidity in the chamber is less than desired, reduce the Air Inject Time.

9.4 CO₂ Calibration

The DH infrared CO₂ sensor may be calibrated using the following technique: Open Door Zero-Span Calibration. CO₂ calibrations can be performed in approximately two minutes, by accessing the CO₂ calibrations menu in “Service Settings” and follow the -screen instructions. To perform the Open-Door CO₂ sensor calibration routine, perform the following:

- Attach independent CO₂ monitoring device to the sample port in the center of the inner glass door of the unit.
- Enter CO₂ calibrations by means of Service Settings.
- Select the “Open Door Zero Span Calibration” text.
- Follow on-screen instructions.

NOTE: The CO₂ sensor has an internal SPAN limit of +/- 8% of the displayed value (i.e. display value is 5%, change up to 5.4% would be accepted by the system). It is always recommended NOT to enter the full measured value into the SPAN when calibrating. This will avoid overshoot and stay on the lower side of the internal CO₂ sensor value tolerance (rounding and significant values). If the CO₂ sensor rejects the SPAN value, either try again or lower the value.

9.4.1 CO₂ Off Set Calibration

CO₂ Off Set Calibration can be performed anytime an independent measurement doesn't correlate to the front panel display. However, this calibration SHOULD NOT BE PERFORMED MORE THAN ONCE PER WEEK. Sensor calibration should be performed if an independent measurement doesn't match the display within ± 0.3 percent within one week after a sensor calibration. Before doing the following calibration, check and change, if necessary, the Incubator in-line filter found within the Sensor Bay.

When unit has stabilized at the operational temperature and CO₂ percentage, take an independent measurement and, if necessary, perform the following:

- In "Service Settings" enter the CO₂ Calibrations menu.
- Press the "CO₂ Offset Calibration" text button.
- Use an independent instrument to determine actual CO₂ percentage (compare the display CO₂ to the independent measurement). If these two readings have a difference equal to or less than 0.5 percent, proceed to enter the CO₂ Fyrite value. This calibration only allows a maximum of 0.5% offset. (See * **Note** below) If the difference is greater than 0.5 percent, it is recommended to perform a CO₂ Open Door Calibration.
- Enter the value measured by the independent device.
- Exit and Save to retain this value.

***Note:** When the display value is more than 0.3% different from the measured value, offset display 1/2 the difference measured. Allow the Incubator to stabilize back to set point, then measure the CO₂ in the chamber again. Offset the display again if necessary.

9.4.2 Closed Door CO₂ Sensor Calibration Routine

- Attach independent CO₂ monitoring device to the sample port in the center of the inner glass door.
- Enter CO₂ calibrations by means of Service Settings.
- Select the "CO₂ Closed Door Zero Span" text.
- Follow on-screen instructions.

Enter measurement on independent device when prompted.

Allow the unit to run and stabilize for a minimum of 2 hours then, check calibration with an independent instrument. Compare the display CO₂ percent to your independent measurement. If these two readings have a difference greater than 0.3%, repeat the above procedure. If these two readings have a difference of less than 0.3%, perform the CO₂ Offset calibration procedure in Section 9.4.1.

9.4.3 Elevation

This setting specifies the elevation. It is used to calculate pressure compensation for the CO₂ sensor. The unit of measure is in feet. The elevation of your area can be entered.

This function is in the service settings – 9876 – Options – Next – Elevation. The elevation can be entered by touching the keypad's current elevation (default is 971 ft) and entering your current elevation. **(Min 0 – Max 30000)**

This will calculate the pressure compensation for the CO₂ sensor and provide a more accurate CO₂ measurement.

10.0 Maintaining Your DH

DH Chamber

The chamber maintenance is up to the discretion of the owner and the extent of cleanliness and sterility desired. The shelves and bracket supports are all removable and autoclavable.

The interior should be wiped down with an appropriate disinfectant such as 70% ISOPROPYL ALCOHOL or equivalent.

NOTE: DO NOT USE ANY CHLORINATED OR HALOGEN MATERIALS IN THE CHAMBER. SUCH MATERIAL IS HARMFUL TO THE POLISHED STAINLESS STEEL.

NOTE: NuAire does not offer any product warranty with respect to cleaning material compatibility. USE AT YOUR OWN RISK! The information provided above is from raw material suppliers and known general source documents for use to develop application cleaning SOP's.

The humidity pan should also be sterilized, and the water changed regularly to assure sterility. A small amount of copper sulfate may be added to the humidity pan to inhibit bacterial growth.

CO₂ Supply Filter

P/N X-980385 (50 mm Disk, Uni-directional In-Line, Dry)*

The CO₂ Supply Filter should be replaced every fifth empty CO₂ tank or when the filter is visibly discolored (yellow-brown).

Sensor Bay Capsule Filter

P/N RF566 (Capsule, Uni-Directional In-Line, Wet)

This Sensor Filter should be replaced EVERY FOUR YEARS to assure optimum performance.

A visual check should be performed when a maintenance reminder appears on the main screen to assure filter integrity.

Remove sensor bay cover to perform a visual check.

See section 10.4 for automatic notification for checking this filter.

Air Supply Filter

P/N X-980385 (50 mm Disk, Uni-directional In-Line, Dry)*

The Air Supply Filter should be replaced every fifth empty CO₂ tank or when the filter is visibly discolored (yellow-brown).

CO₂ Sensor Filter

P/N X-980366 (50mm Disk, Uni-Directional In-Line, Wet)*

The Air Pump Filters should be replaced EVERY TWO YEARS to assure optimum performance.

A visual check should be performed during CO₂ sensor calibration to assure filter integrity.

Remove the sensor housing cover to perform a visual check.

NOTE: The word "In" on the outer rink of the body indicates the inlet side of the filter and should be installed toward the gas supply.

10.1 Chemical Decontamination of the Incubator Chamber

To chemically decontaminate NuAire Incubator inner chambers, users may use the traditional formaldehyde or Chlorine Dioxide in gas form, or Vapor Phased Hydrogen Peroxide.

All three of the chemicals are compatible to all parts within NuAire Incubator chambers.

The incubator should be turned off during these procedures.

NOTE: As stated previously, the chamber and components can also be wiped down with a 70% solution of Isopropyl Alcohol for cleaning and decontamination.

10.2 Power Loss Recovery Mode

When an incubator experiences a sudden loss of power there is an increased chance of condensation building up in the circulation system tubing. This mode helps to dissipate that buildup before it causes the sensors to fail.

- Conditions for entering mode: - Incubator must be without power for 45 minutes or longer. This includes first time setup. Mode is automatically triggered after power is restored (after 45+ min outage). If less than 45 minutes have passed incubator will enter normal Run mode.
- When in Power Loss Recovery Mode:
 - o Blocking solenoid will be turned "ON" which will bypass the CO₂ and O₂ sensors in the circulation system.
 - o Both systems will be put in standby mode meaning they will not control or alarm while in this mode.
 - o "Power Loss Recovery" shows in place of "RUN" in the main screen.
 - o Heaters and Air Pump run as normal.
- Once entered, this mode will run for 1 hour. A count down timer screen (see below) can be found when pressing the CO₂ or O₂ Diagnostics button in the Service Settings screen. It is also recorded in the event log.

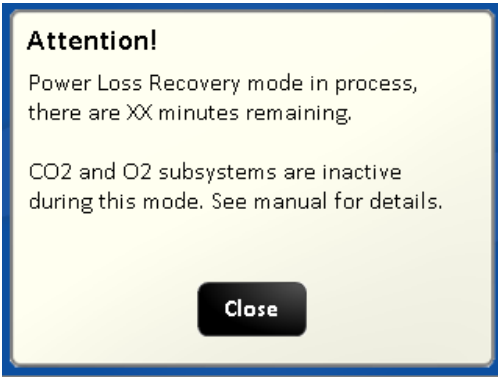

10.3 Shutting down the Incubator

Prior to shutting down the Incubator open the inner and outer doors and remove the water pan. Leave doors open for at least 5 minutes prior to shutting it off. This will purge the chamber, circulating system and the sensors of humidity that could condense and cause faulty readings when the Incubator is turned back on. Be sure to empty the water pan prior to putting it back into the chamber if the Incubator is going to be shut off for any length of time.

10.4 Automatic Filter Change Notification

The Capsule filter located in the Sensor Bay (see BCD- 18318 for location) should be checked on average every 2 years to see if it should be changed. The Filter material is normally a white material. Discoloration of the filter material is an indicator that it should be changed. Retro Fit Kit RF566 should be ordered for the replacement filter. A timed notice triggers a Maintenance Notification button in the Main Screen when this timer counts down to zero. Pressing the Maintenance Required button produces a screen indicating that the timer for filter life has expired.

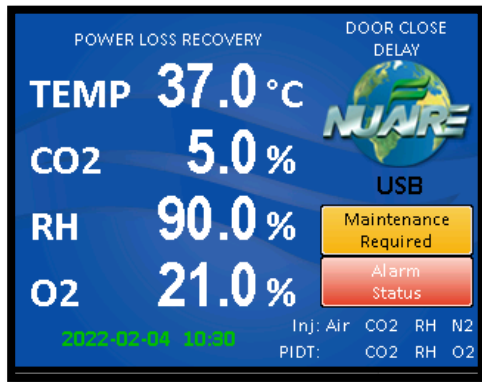

Responding to the notification:

From the main screen press the NuAire Logo / Service settings / General Option /Next / Filter Maintenance to access the Filter Maintenance screen. In these screens you can:

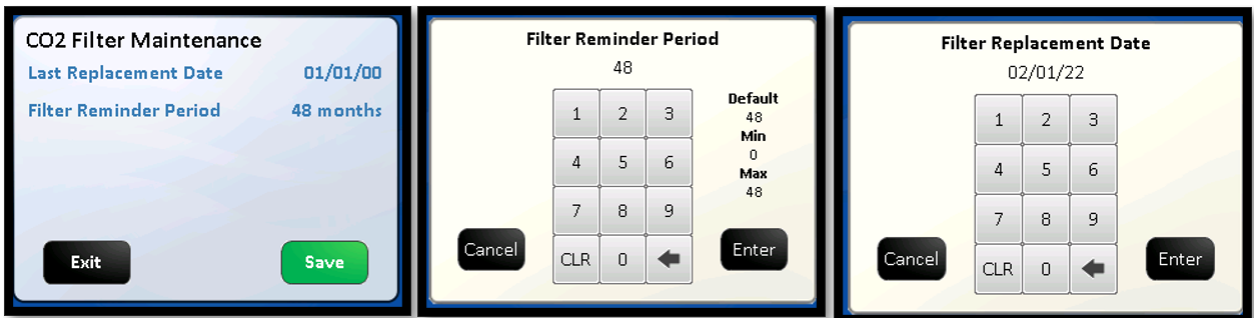

- Extend the alarm by 1 month by pushing the Last Replacement Date, date displays, extend the date by one month button. Press the Enter, Save, and Exit button to retain the extension and go to the General Settings screen. Pressing Save will not retain the time extension.
- Reset the notification timer by pressing Last replacement date and extending date by one month.
- Press the Save button to save the timer setting and go the General Setting screen.
- Setting the timer to 0 months deactivates the notification.

After extending or resetting the timer you can return to the main screen by following the screen prompts.

11.0 Error Indicators & Troubleshooting

Step 1 NOTE ALL ERROR INDICATORS.

When the Incubator is running, the Alarm Status button indicates an error.

Pressing the Alarm Status button, entering the correlating Alarms Menu and pressing the Silence button in the Alarms Menu will silence the audible alarm until Diagnostics is entered or another alarm becomes active.

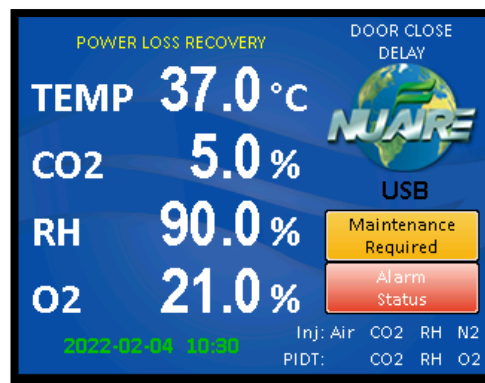

Step 2 CLEAR ERROR INDICATORS.

Error indicators can be cleared by pressing the Alarm Status button and entering the Alarms Menu and pressing the Clear All button; if the error is still present the indicator will return when the alarm time reaches 0.

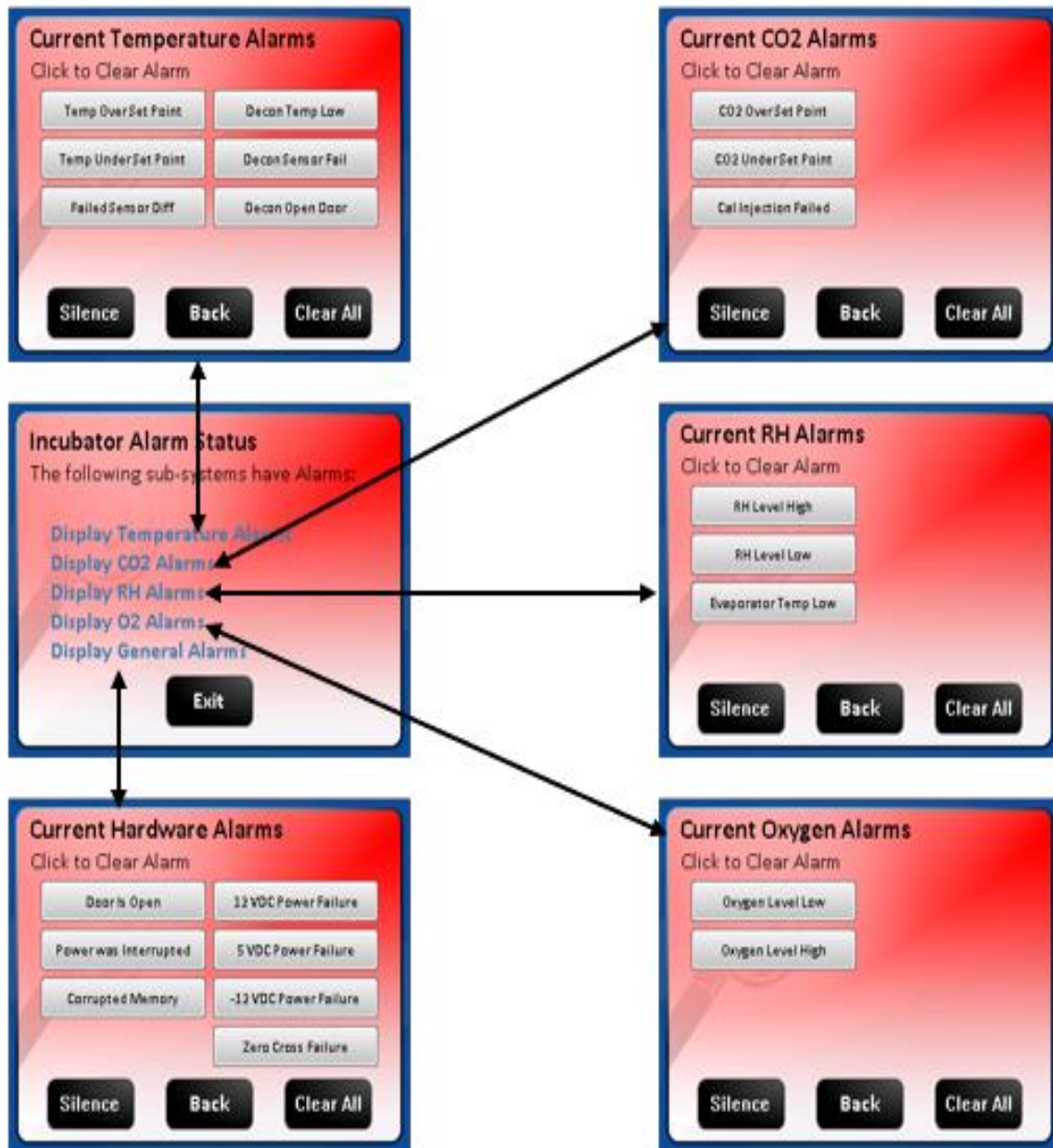

Step 3 MONITOR REOCCURRENCE OF ERROR INDICATORS.

If recurrence of the error indicator is immediate or daily, use the Error Indicator Troubleshooting Guide on the following pages to address the issue indicated by the reoccurring alarm.

Error Indicator Troubleshooting Guide

Temperature System		
Displayed Error Code	Code Description	Checks and Corrections
Temp Over Set Point,	-Temperature over setpoint	Check temperature sensor calibration. Faulty TRIAC, replace control board.
Temp Under Set Point,	-Temperature time out error during normal running and in	Check temperature sensor calibration. Replace fuse. Faulty TRIAC, replace control board. Faulty chamber heater contact NuAire Technical Service. Door/Perimeter heater needs to be increased with a high temperature set-point in a low ambient temperature
Failed Sensor Differential	-Sensor temperature (differential) error normal running. -Occurs when difference between sensors exceed 4°C.	Check temperature sensor calibration. Check connection on control board. One or both temp sensors faulty, replace
Maintenance Required	Breakdown in communication	One or both temp. sensors disconnect, check connection of temp. sensors between main and display boards

CO ₂ Sensor Bay Heater		
Displayed Error Code	Code Description	Checks and Corrections
Sensor Bay Temp Low	Sensor bay temp less than Temp Set Point +2 degrees	Check control board output to heater, replace board if faulty. Check heater for loose connections. Check sensor bay heater for function, replace if faulty.
Sensor Bay Temp High	Sensor bay temp is above 65° C	Check control board output to relay, replace board if faulty. Check that all connections are secure. Check sensor bay heater for function, replace if faulty. Check for uncontrolled sources of heat influencing the bay.

CO ₂ System		
Displayed Error Code	Code Description	Checks and Corrections
CO₂ Over Set Point	- CO ₂ over setpoint	Perform CO ₂ sensor calibration. Check injection solenoid for leaking valve. Check sensor and disk filter for condensation
CO₂ Under Set Point	- CO ₂ time out error. The measured CO ₂ level has not reached with in the allowed percentage in the allowed time. CO ₂ stops injecting and air is injected for 15 minutes in case the sensor is not detecting the CO ₂ .	Check CO ₂ gas supply - inline gas filters, CO ₂ gas tank pressure, CO ₂ sensor function Check/replace CO ₂ gas supply tanks. Check for leaks in chamber. inner door gasket, chamber recirculation tubes Check for leaks in air pump and hosing
Cal Inject Failed	- Cal inject calibration failed. Not enough increase in the CO ₂ reading after gas was injected.	Check gas supply then run calibration again. Call NuAire Technical Services if error persists.

General Indicators		
Displayed Error Code	Code Description	Checks and Corrections
Door Ajar/rapid beeping	- Inner glass door is not closed or the door switch needs attention.	Close and latch the inner glass door. Confirm placement on the Control Board Check door switch, if faulty, replace.
"Power Interruption" Text replacing NuAire Logo	- Interruption of power	Press any key to dismiss the power interruption notice.
Date/time flashing	- Interruption of power	Flashing Green: Indicates that the real time clock did not lose power. See section 8.7.1.1 to address this. Canceling or saving in the clock set screen will return to the main screen and stop the flashing. Flashing Yellow Indicates the real time clock lost backup power and needs to be set again. See section 8.7.1.1 to address this. Save must be pressed in the clock set screen to stop the flashing and return the date and time to green text.
Power Loss Recovery Mode	Displayed in main screen in place of RUN or STANDBY.	Shows when incubator has lost power for more than 45 minutes long enough to get condensation in the circulation system and cause the CO ₂ and O ₂ sensors to malfunction. This mode blocks circulation through the sensors and does not control the gas for 1 hour to allow the condensation to dissipate. Gas control is then resumed.
Corrupted Memory	Corrupted memory was detected during boot up of the incubator	Replace Control Board
Data Write Failure	A change in parameters failed to write to memory	Replace Control board
+12 VDC Power Failure	Low voltage detected on the +12 VDC power circuit	Check output @ Power Supply-If good could be Control Bd Check power supply connection to Control board DC power supply failed - replace
-12 VDC Power Failure	Low voltage detected on the -12 VDC power circuit	Check output @ Power Supply-If good could be Control Bd Check power supply connection to Control board DC power supply failed - replace
5 VDC Power Failure	Low voltage detected on the 5 VDC power circuit	Check output @ Power Supply-If good could be Control Bd Check power supply connection to Control board DC power supply failed - replace
Zero Cross Failure	The Power Triacs control circuit not working	Check for loose line voltage connection to control board. Replace fuse with slow blow fuse of the correct amp rating as specified on the wiring diagram. Replace Control Board
Universal Serial Bus Error	Stops trying to write to USB memory stick after several tries	Memory stick not compatible try another one. May take several tries. USB port not functioning contact NuAire technical service
Condensation Excessive (Using Water Pan) See section 9 for more detailed instructions	On Glass Door	Increase Door heater duty cycle in 5% increments or less at a time
	On inner door gasket and/or front of the chamber	Increase Perimeter heater duty cycle in 5% increments or less.
	On any wall toward back of chamber	Decrease door then perimeter heater duty cycles in 5% increments or less.
NOTE: Depending on the room ambient that the Incubator is operating, the operator may have to readjust the door and perimeter heater duty cycle are too high and likewise if the door and perimeter heater duty cycles are too low the glass door and front wall of the chamber will show excessive condensation.		
Condensation Persists After Door and Perimeter Duty Cycles are Adjusted		Increase air injections, increasing duration first, recommended initial change to 15 (sec) (Air Inj default is 10)) & 1 minute (Air Cyc)

General Indicators		
Displayed Error Code	Code Description	Checks and Corrections
Condensation on the face of the incubator outside of the chamber	Pressure in chamber high enough to cause blow by around the inner door gasket	Check side access port stopper pressure relief hole(s) for blockage. Check circulation system for blockage causing flow out of the chamber to be less than flow into the chamber.
Excess Vibration		Check jacket fan mounted in bottom of Incubator

For further assistance, call NuAire Customer Service at 1-800-328-3352 or (763) 553-1270 USA.

12.0 Communication Outputs

12.1 Remote Alarm Contacts

The NuAire DH Incubator contains a set of contact points to connect to a remote alarm system. The contacts are located on the rear panel (see page 14). The contacts are housed in a modular (RJ-11) telephone jack and rated for (30V at 1 Amp). The contacts provided are normally open (NO), normally closed (NC) and common (COM) as shown below. The alarm contacts do not distinguish between a CO₂ temperature and any other alarm. Each will open or close the contacts upon an alarm condition. Power interruption will also change the state of the contacts.

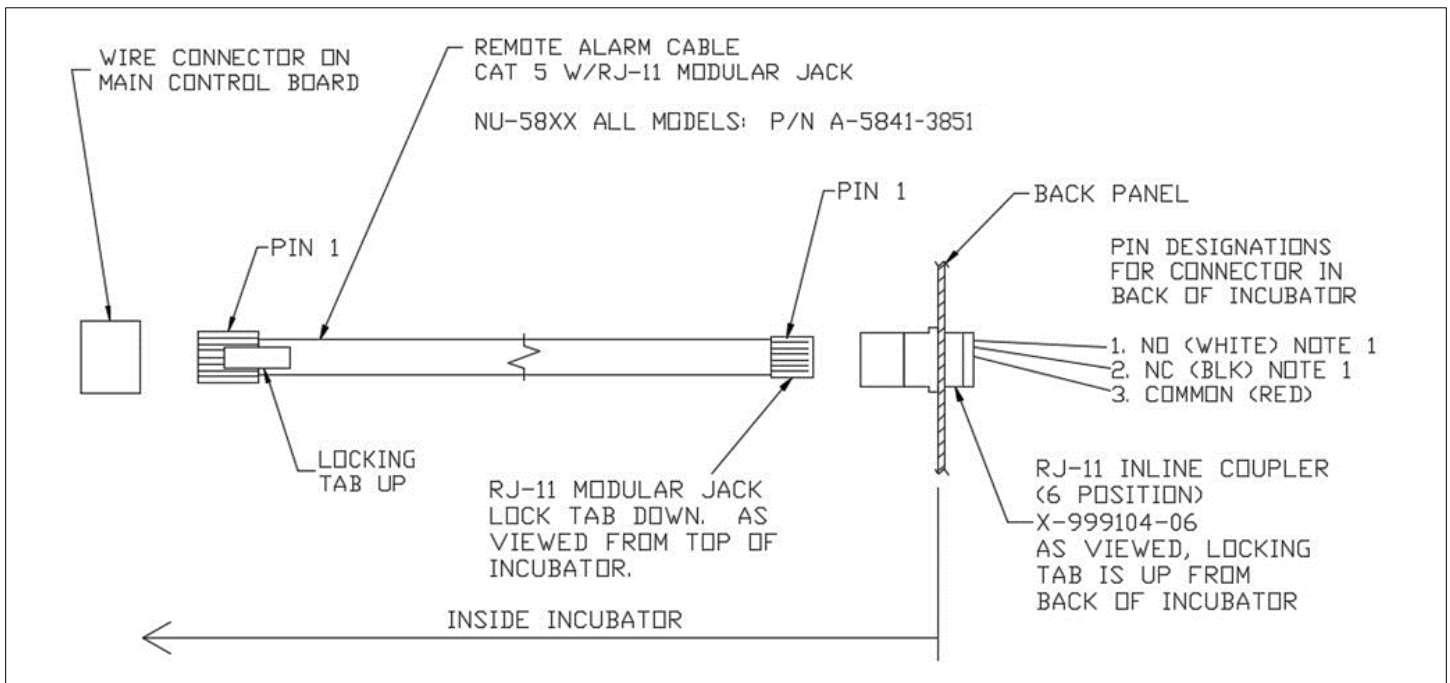

NOTE: The relay is powered when the incubator is turned on in order to detect a power interruption. The relay contacts are in their normal state (NO, NC) when there is an alarm or during the loss of power to the incubator control board.

- | | |
|--|--|
| 12.2 4 to 20mA Analog System Performance Output: | Refer to PTB0235 Revision 3 or higher. |
| 12.3 RS-485 2-way Communications: | Refer to PTB0234 |
| 12.4 On-Board USB Port: | |
| Uploading Service Performance/Event Data: | Refer to STB0348 |
| Uploading Incubator Programming: | Refer to STP0347 |



When connecting external accessories or components to the system, attach only components that have been tested and certified for compliance to UL/IEC 60601-1 or UL/IEC 60950

13.0 Electrical/Environmental Requirements

13.1 Electrical (Supply voltage fluctuations not to exceed +/- 10%)

NU-5700	115V,	50/60Hz,	1 Phase,	4.1 Amps
NU-5700E	230V,	50/60Hz,	1 Phase,	2.1 Amps

Start Up Power 435 Watts

Running Power 200 Watts

13.2 Operational Performance (for indoor use only)

Environment Temperature Range: 60°F-85°F (15.5°C – 29.4°C)

Environment Humidity: Maximum relative humidity 80% for temperatures up to 31°C decreasing linearly to 50% relative humidity at 40°C

Environment Altitude: 6562 ft (2000 m) over sea level maximum

13.3 Light Exposure

Standard Lighting @ 150 ft. candles (1614 LUX) maximum intensity.

13.4 Installation Category: 2.0

Installation category (overvoltage category) defines the level of transient overvoltage, which the instrument is designed to withstand safely. It depends on the nature of the electricity supply and its overvoltage protection means.

For example, in CAT II, which is the category used for instruments in installations supplied from a supply comparable to public mains such as hospital and research laboratories and most industrial laboratories, the expected transient overvoltage is 2500V for a 230V supply and 1500V for a 120V supply.

13.5 Pollution Degree: 2.0

Pollution degree describes the amount of conductive pollution present in the operating environment.

Pollution degree 2.0 assumes that normally only non-conductive pollution such as dust occurs with the exception of occasional conductivity caused by condensation.

13.6 Chemical Exposure

Chemical exposure should be limited to antibacterial materials used for cleaning and disinfecting.

Chlorinated and Halogen materials are not recommended for use on stainless steel surfaces.

Chamber decontamination can be accomplished by paraformaldehyde, vapor phased Hydrogen Peroxide or Ethylene Oxide without degradation of cabinet materials.

13.7 EMC Performance (classified for light industrial)

Emissions: EN61326

Immunity: EN61326



Class A equipment is intended for use in an industrial environment.

In the documentation for the user, a statement shall be included drawing attention to the fact that there may be potential difficulties in ensuring electromagnetic compatibility in other environments, due to conduction as well as radiated disturbances.

13.8 Heat Rejection: 14 BTU/Minute

14.0 Disposal and Recycle

Incubators that are no longer in use and are ready for disposal contain reusable materials. ALL components with the exception of the HEPA filters may be disposed and/or recycled after they are known to be properly disinfected.

NOTE: Follow all local, state, and federal guidelines for disposal of HEPA filter solid waste.



BIOHAZARD



Prior to any disassembly for disposal the incubator must be decontaminated



RECYCLE



LEAD FREE

Component	Material
Incubator Cabinet	Painted Steel
Outer Door	Painted Steel
Chamber	Stainless Steel
Outer Door Gasket	Vinyl Clad Magnet
Inner Door Gasket	Silicon Rubber
Front Service Panel	Painted Steel
Electronics Panel	Painted Steel
Sensor Bay	Aluminum
Exhaust Filter	Aluminum
Hosing	Silicon Rubber
Tubing	Stainless Steel
Air Pump	Various Steel/Copper/Nylon
Motor	Various Steel/Copper/PVC
Printed Wiring Assembly	Lead Free Electronic
Wire	PVC Coated Copper
Solenoid Valves	Various Steel/Copper
Connectors	PVC
Hardware	Stainless Steel and Steel

NOTE: Material type can be verified with use of a magnet with stainless and aluminum being non-magnetic.

REV	ECO	DESCRIPTION	DATE	DFTM	CHKD
D	13063	UPDATED TO INCORPORATE NU-5700, UPDATED POWER SUPPLY	9/26/2016	TH	KCK

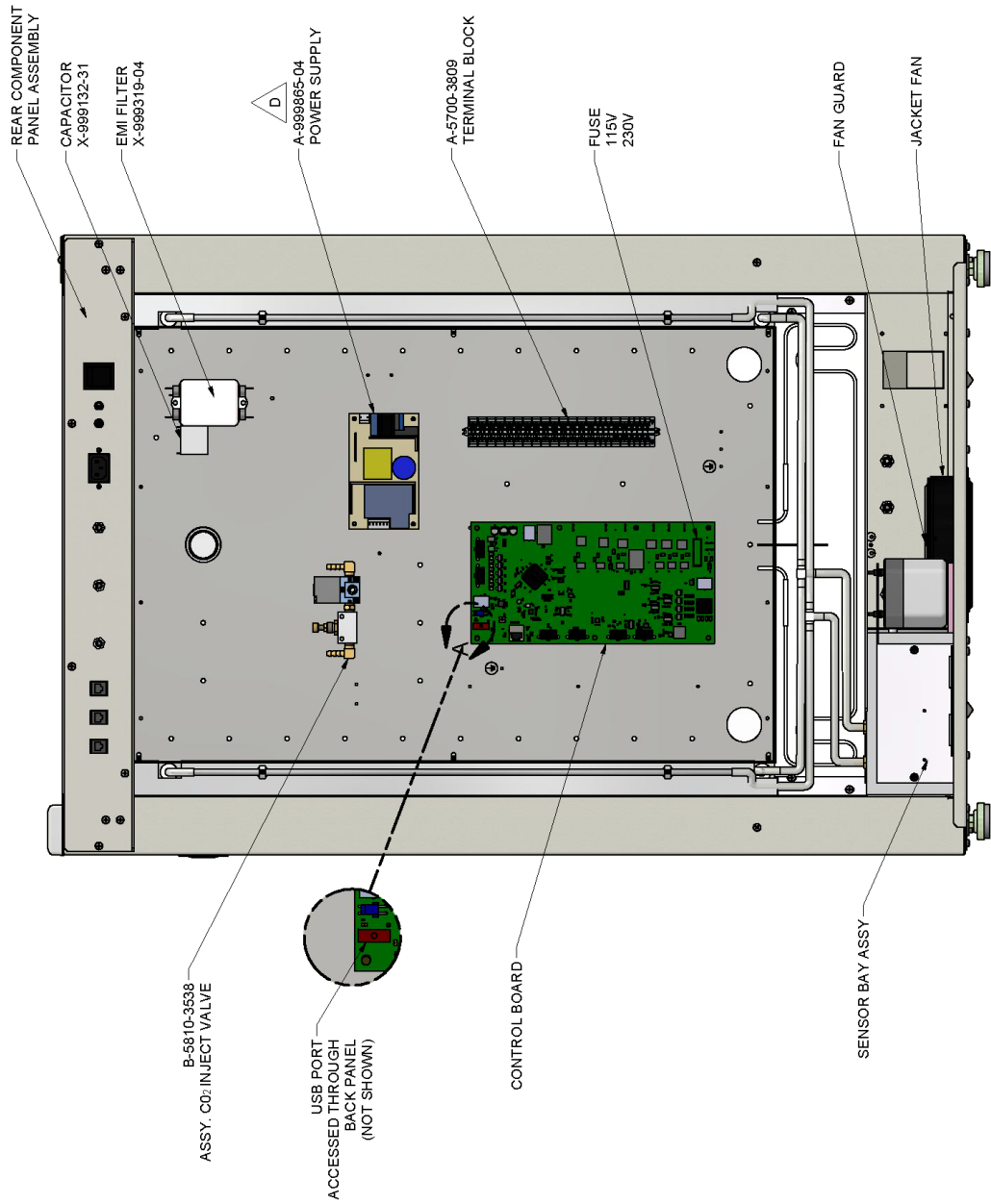

TITLE DH INCUBATOR ELECTRONICS PANEL ASSEMBLY	
DFTM L.S.	DATE 3/1/2012
CHKD KCK	SHEET 1 OF 1
DRAWING NUMBER	BCD-15177
	D

REV	ECO	DESCRIPTION	DATE	DTM	CHKD
A	13863	RELEASED TO PRODUCTION	10/17/2018	TH	JCP

Parts List						
ITEM	QTY	PART NUMBER	100V	115V	230V	DESCRIPTION
1	1	A-5800-3403-TAB	-03	-01	-02	NIJ-5800 SENSOR BAY HEATER
2	1	B-5800-3487				Air Inject Solenoid Assembly
3	1	B-5800-4089				Sensor Box
4	1	X-990386				In-Line Wet Filter
5	4	X-980372-06				Single Barb 90 Degree Nylon Elbow Fitting
6	1	X-980398-02				Solvent Resistant Filter
7	1	X-980696-02				Union Bulkhead Nickel Plated .25id3/8Od
8	1	X-999347-TAB	-03	-04	-05	HiFlow 115V 60Hz Air Pump
9	1	X-999605-06-A				TEMP SENSOR 105° PROBE
10	AIR	X-999731-12				EXPANDABLE BRAID TUBE .75 X 250"
11	1	X-999905-09				Digital Infrared CO2 Sensor
186	2	A-5800-3405				Sensor Bay Front Insulated Cover
187	1	A-5800-3404				Sensor Bay Insulated Cover with Cutout

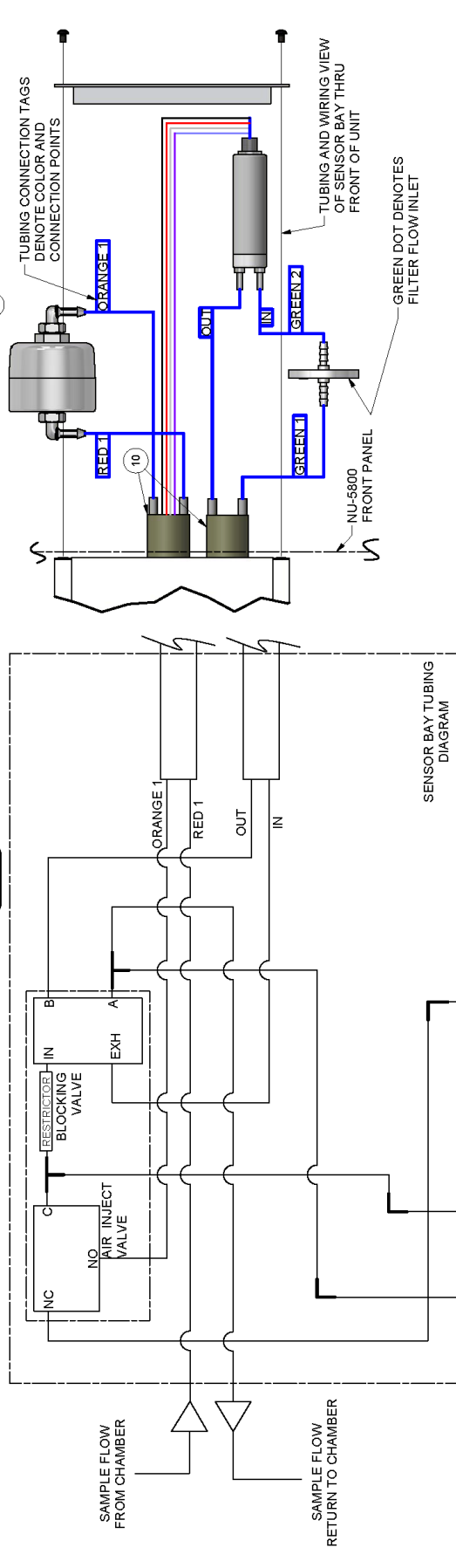
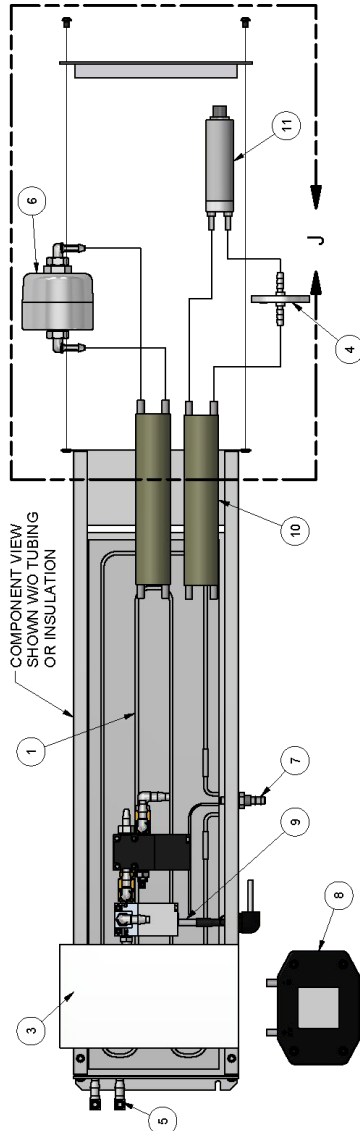

TITLE DH INCUBATOR SENSOR BAY ASSEMBLY						
DTM	DATE	CHKD	SHEET	1	OF	1
TH	10/16/2018	JCP				
DRAWING NUMBER			BCD-20374			
			A			

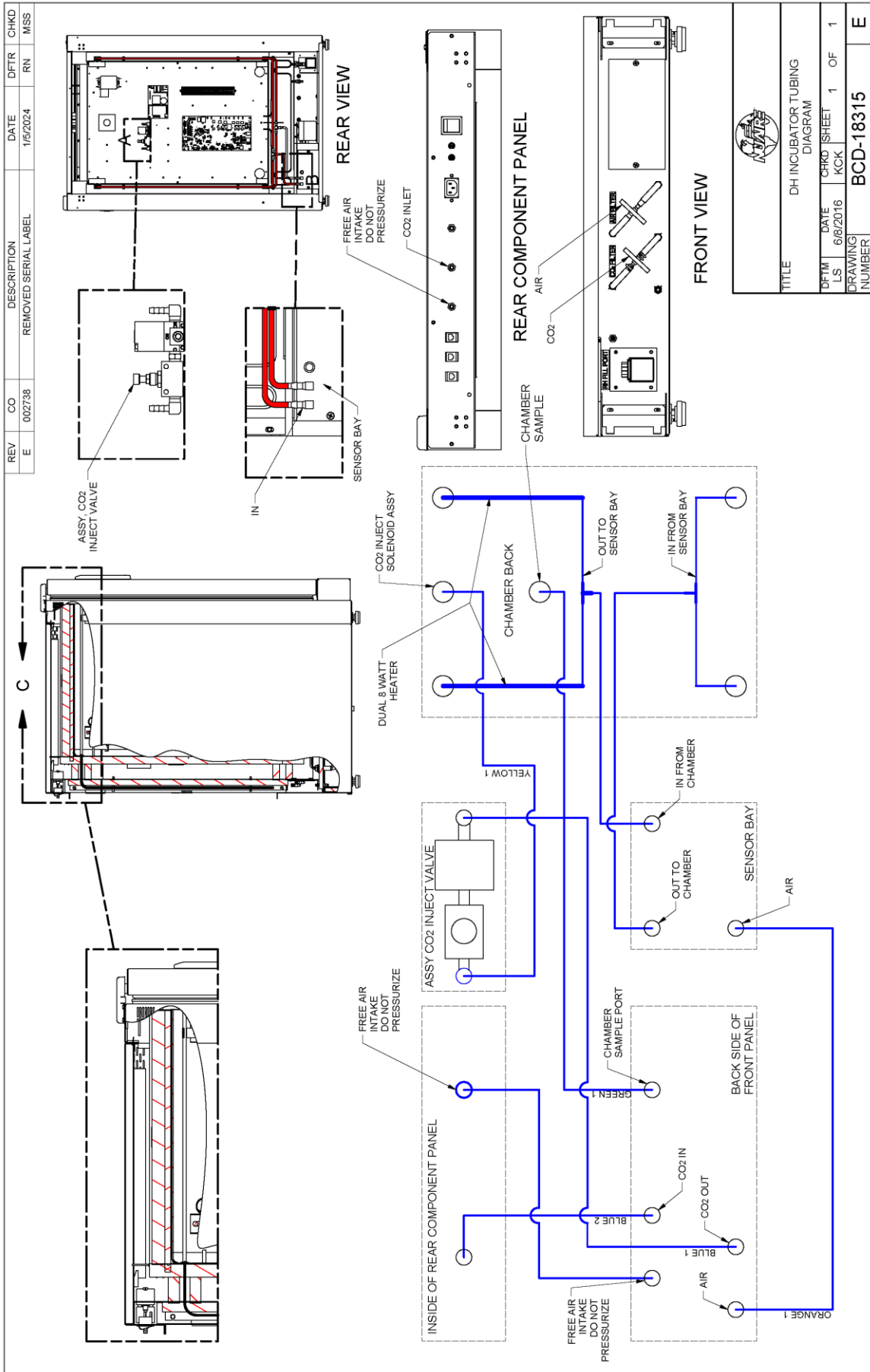

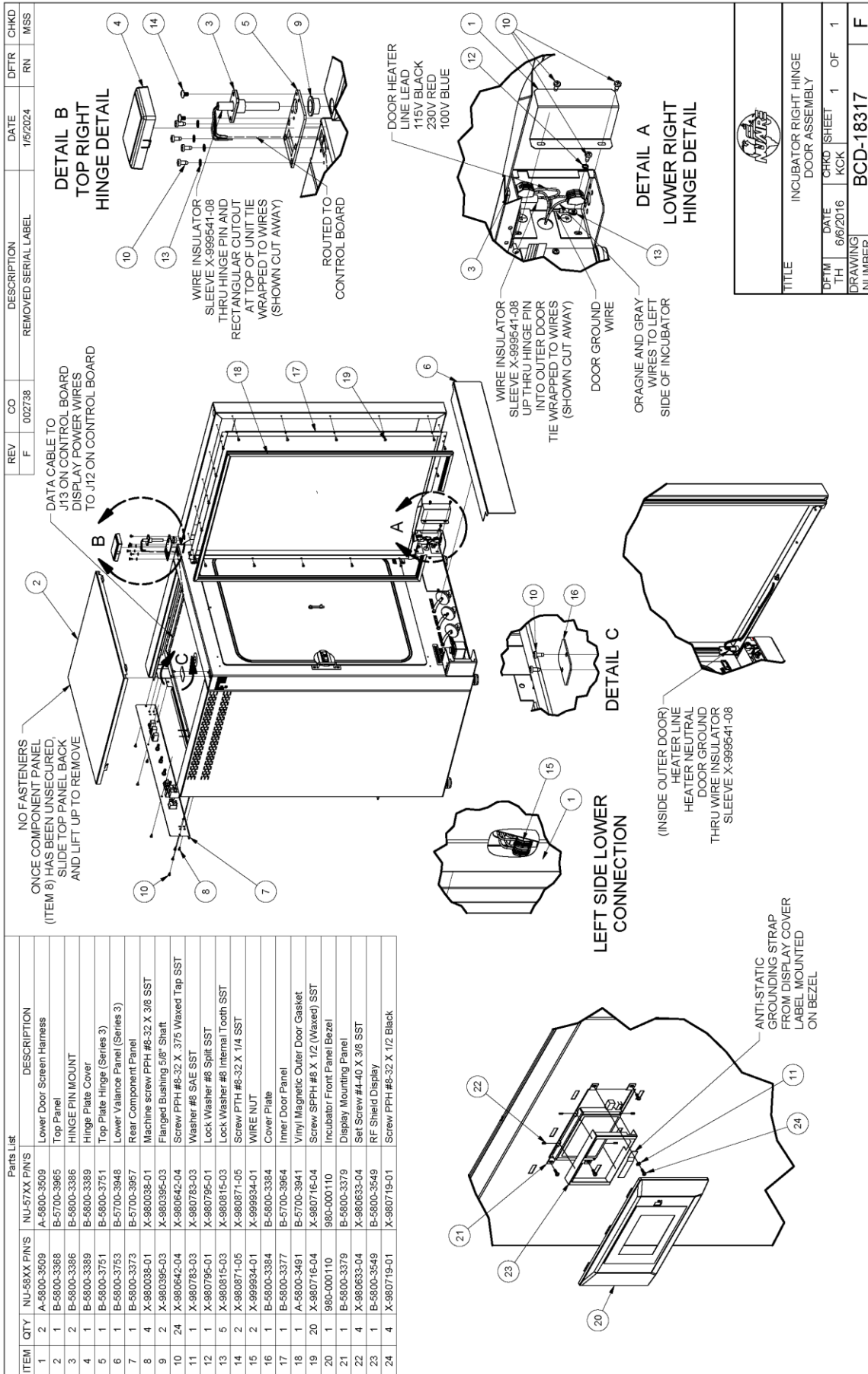

TITLE			
INCUBATOR RIGHT HINGE DOOR ASSEMBLY			
DFTM	DATE	CRD (SHEET)	OF
TH	6/6/2016	KKK	1
DRAWING NUMBER			F
			BCD-18317

REV	CO	DESCRIPTION	DATE	DFTR	CHKD
F	002738	REMOVED SERIAL LABEL	1/5/2024	RN	MSS

REV	CO	DESCRIPTION	DATE	DFTR	CHKD
F	002738	REMOVED SERIAL LABEL	1/5/2024	RN	MSS

ITEM	QTY	NU-56XX P/N'S	NU-57XX P/N'S	DESCRIPTION
1	2	A-5800-3509	A-5800-3509	Lower Door Screen Harness
2	1	B-5800-3368	B-5700-3965	Top Panel
3	2	B-5800-3386	B-5800-3386	HINGE PIN MOUNT
4	1	B-5800-3389	B-5800-3389	Hinge Plate Cover
5	1	B-5800-3751	B-5800-3751	Top Plate Hinge (Series 3)
6	1	B-5800-3753	B-5700-3948	Lower Valance Panel (Series 3)
7	1	B-5800-3373	B-5700-3957	Rear Component Panel
8	2	X-989541-01	X-989541-01	WIRE NUT
9	4	X-980038-01	X-980038-01	Machine screw PPH #8-32 X 3/8 SST
10	2	X-980395-03	X-980395-03	Flanged Bushing 5/8" Shaft
11	24	X-980642-04	X-980642-04	Screw PPH #8-32 X .375 Waxed Tap SST
12	1	X-980783-03	X-980783-03	Washer #8 SAE SST
13	1	X-980795-01	X-980795-01	Lock Washer #8 Split SST
14	5	X-980815-03	X-980815-03	Lock Washer #8 Internal Tooth SST
15	2	X-980871-05	X-980871-05	Screw PTH #8-32 X 1/4 SST
16	1	B-5800-3384	B-5800-3384	Cover Plate
17	1	B-5800-3377	B-5700-3964	Inner Door Panel
18	1	A-5800-3491	B-5700-3941	Vinyl Magnetic Outer Door Gasket
19	20	X-980716-04	X-980716-04	Screw SPPH #8 X 1/2 (Waxed) SST
20	1	980-000110	980-000110	Incubator Front Panel Bezel
21	1	B-5800-3379	B-5800-3379	Display Mounting Panel
22	4	X-980663-04	X-980663-04	Set Screw #4-40 X 3/8 SST
23	1	B-5800-3549	B-5800-3549	RF Shield Display
24	4	X-980719-01	X-980719-01	Screw PPH #8-32 X 1/2 Black

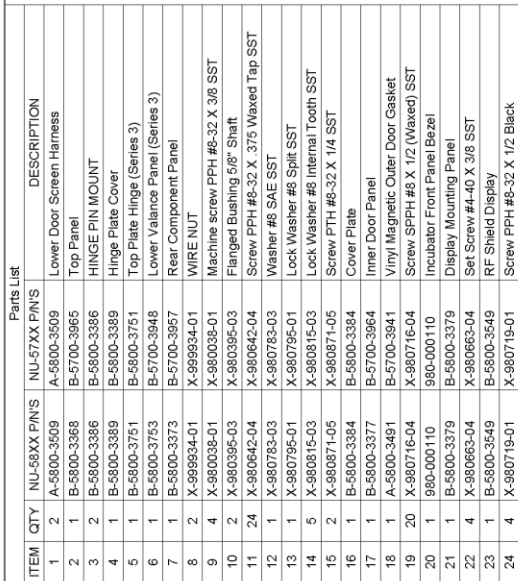

TITLE		INCUBATOR LEFT HINGE DOOR ASSEMBLY	
DFW	DATE	CRD	SHEET
TH	6/6/2016	KCK	1 OF 1
DRAWING NUMBER	BCD-18321		
	F		

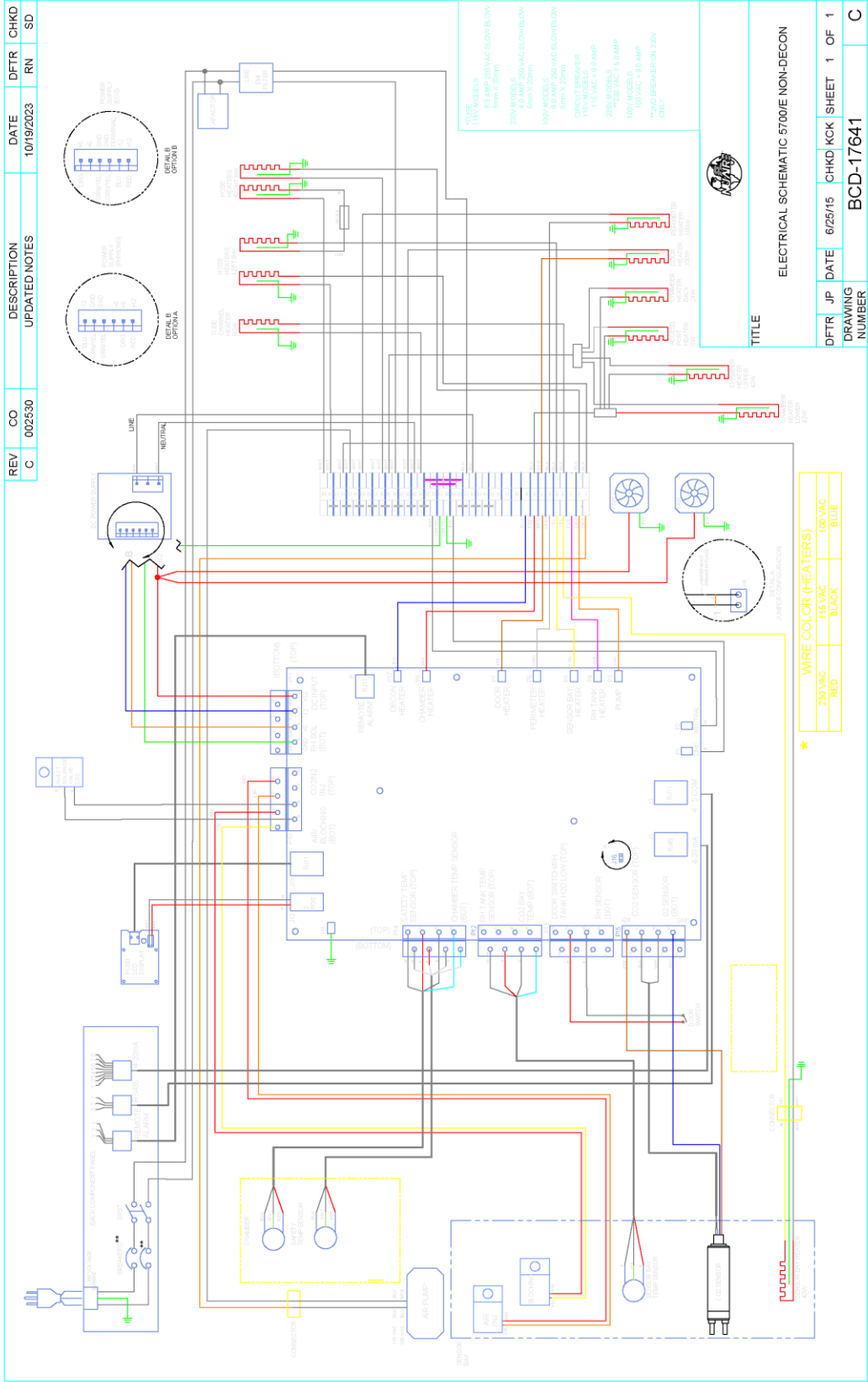

REV	CO	DESCRIPTION	DATE	DFTR	CHKD
C	002530	UPDATED NOTES	10/19/2023	RN	SD

DFTR	JP	DATE	CHKD	KCK	SHEET	1 OF
		6/25/15			1	1

DRAWING NUMBER: BCD-17641

C

TITLE: ELECTRICAL SCHEMATIC 5700E NON-DECON

REV	ECO	DESCRIPTION	DATE	DRAFT/CHKD
A	12870	RELEASED TO PRODUCTION	12/04/15	LS KCK

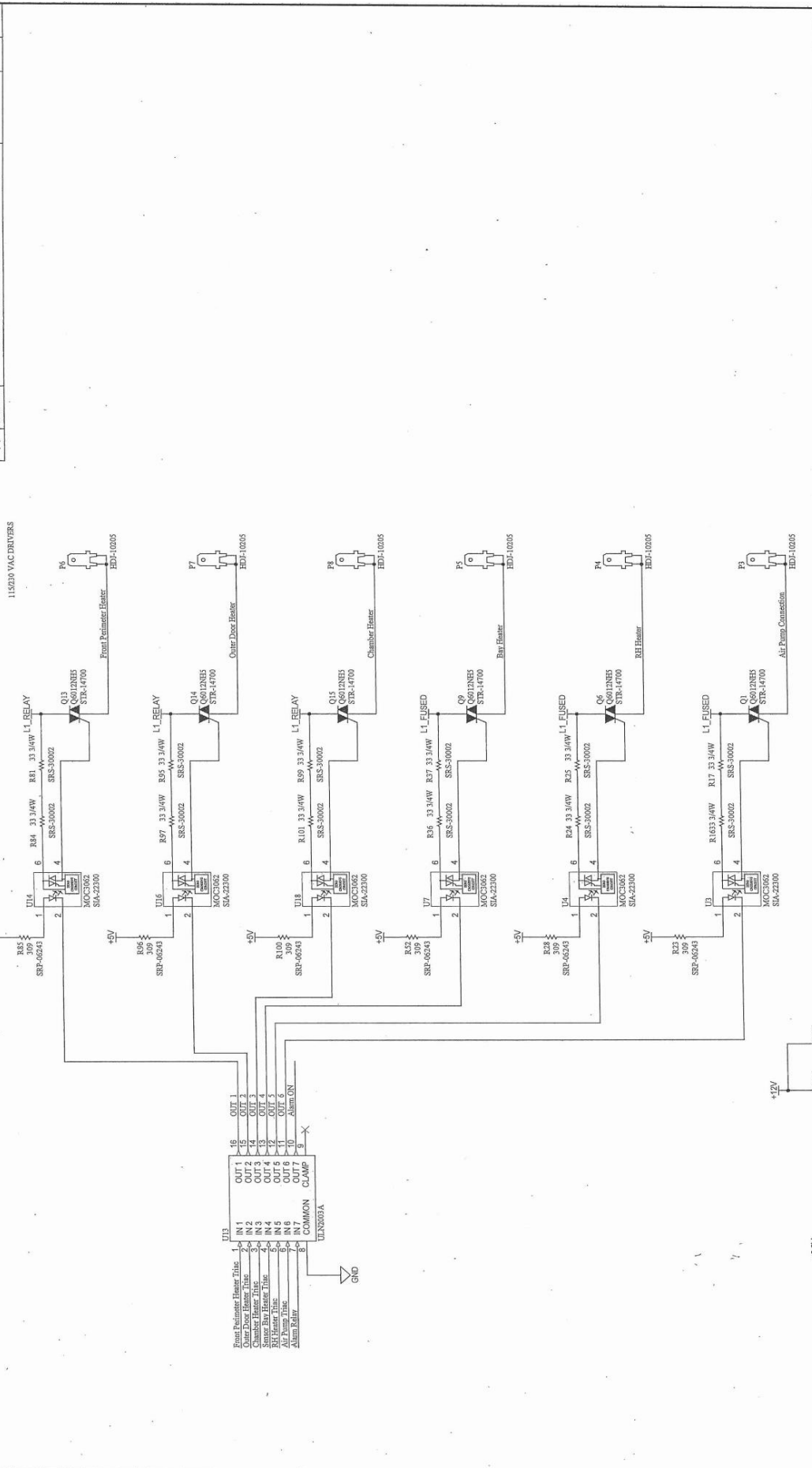



ORIGINAL
 NU-5800 CONTROL BOARD
 OUTPUTS SCHEMATIC

DFTM/LS	12/04/15	CHKD/KCK	SHEET 1 OF 1
DRAWING NUMBER	BCD-18007		A