

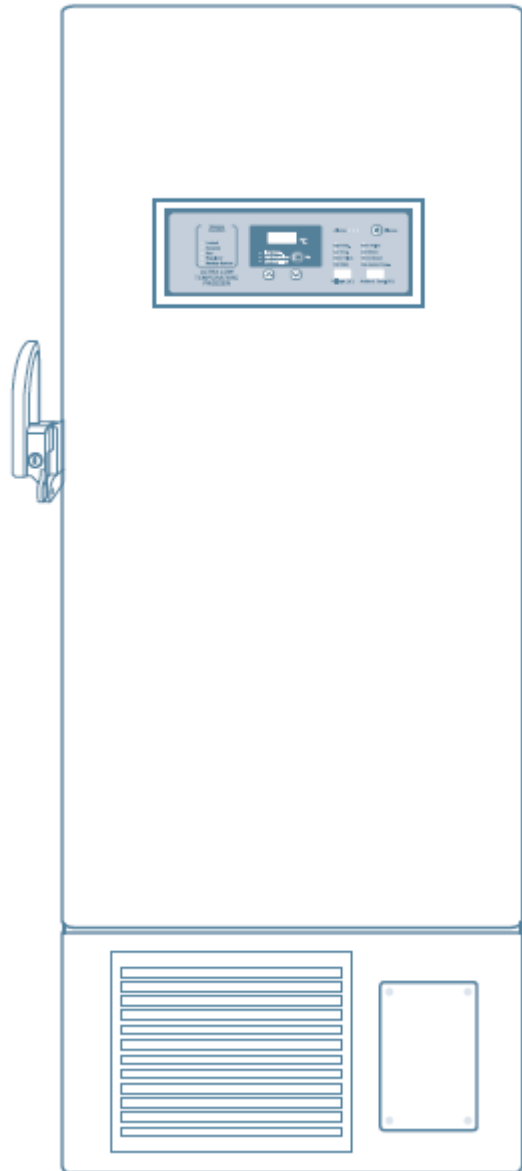

Introduction

Models:

NU-99338JE
NU-99486JE
NU-99578JE
NU-99728JE
NU-99828JE
NU-99420JE
NU-99338JGA
NU-99578JGA
NU-99728JGA
NU-99338JG
NU-99578JG
NU-99728JG
NU-99828JG
NU-99420JG





Contents:

Product Features

- 1.0 It merits your trust from beginning to end
- 2.0 Temperature Control
- 3.0 Security System
- 4.0 Refrigeration system
- 5.0 User friendly design
- 6.0 Safety Label and Safety Precautions
- 7.0 Usage Precautions

Installation

- 8.0 Installation environment
- 9.0 Installation Location
- 10.0 Before Use Preparation
- 11.0 Initially Powering up
- 12.0 Operation after a power Outage
- 13.0 Freezer Parts
 - 13.1 Vertical Type
 - 13.2 Horizontal Type
- 14.0 Control Panels
- 15.0 How to Use the Freezer
 - 15.1 Unlocking the Freezer
 - 15.2 Setting the inner temperature
 - 15.3 Setting the high temperature alarm
 - 15.4 Setting the security code
 - 15.5 Setting the startup delay timer
 - 15.6 Alarm Test and low battery Test
 - 15.7 Setting the USB storage time
 - 15.8 Exporting USB data
- 16.0 Display and Alarm
- 17.0 Cleaning and Maintenance
- 18.0 Recycling the Rechargeable Battery
- 19.0 Optional Accessories
- 20.0 Troubleshooting
- 21.0 Refrigeration and Wiring Diagram
 - 21.1 Refrigeration Diagram
 - 21.2 Wiring diagram
- 22.0 Specifications, Technical Data and Packing list
 - 22.1 Specification
 - 22.2 Technical Data
 - 22.3 Packing List

Warning:

A review should be conducted to establish risk associated with electromagnetic compatibility. In the documentation for the user, a statement shall be included indicates potential difficulties in ensuring electromagnetic compatibility in other environments due to conductive as well as radiated disturbances.



1.0 It merits your trust from beginning to end.

This Product is suitable for the ultra-low temperature storage of products in applications such as clinical pharmaceutical, scientific research, and epidemic institutions. It also can be used in blood stations, hospitals, centers for disease prevention and control, science and research institutions, electronic and chemical laboratories, biomedical engineering institutions, and open sea fishery companies to store red blood cells, white blood cells, viruses, germs, skin, bones, bacteria, sperm, biological products, electronic components, and low temperature testing samples of special products, etc.

2.0 Temperature Control

Temperature is controlled by computer and numerically displayed and regulated in units of 1°C; temperature range: -40°C to -86°C.

3.0 Security System

- Various malfunction alarms (high temperature alarm, power failure alarm, probe failure alarm, hot condenser alarm, high ambient temperature alarm, door open alarm, low battery alarm).
- Two types of alarms (Buzzer sounding alarm, Flashing light alarm).
- Protective functions (password protection, power up delay protection).
- All independent components are safely grounded.

4.0 Refrigeration system

- Optimized multiple refrigeration technology with top brand compressors offering better refrigeration capability.
- Excellent temperature stability.
- Exclusive sealing structure of multiple doors and hot tubing for condensation prevention and front reduction.
- Specially designed low temperature computer control, to prevent the normal redundant.
- System from being erroneously controlled by the low temperature compressor.

5.0 User friendly design

- Equipped with LED display which can show the inner temperature, set temperature, ambient temperature and input voltage. The display can also be used to set the high/low temperature alarm and inner temperature, as well as show any malfunction alarms.
- Designed with adjustable shelves suitable for product storage.
- Safe lock design prevents accidental opening of doors.
- Broad ambient temperature range design, suitable for usage to 32°C environments.
- Innovative design with integrated door locks and compact leveling legs, which are flexible and convenient.
- Automatically open and close condensation fan to save energy.
- Equipped with networks, remote alarm functions which are advanced and practical.
- USB standard.

6.0 Safety Labels and Safety Precautions

Dear Customer

Please read this manual for safe operation and use of this product.

Safety Labels



The upper and lower limits of temperature shall be indicated adjacent to the upper and lower horizontal lines.	Symbol for "Manufacture"
Symbol for "Consult instructions for use"	Symbol for "Date of manufacture"
EC REP European Authorized Representative	European Contact: ibs I tecnomara GmbH Ruhberg4 D-35463, Fernwald, Germany



Wear Crygloves before opening the door.



No sitting



Grounding mark



Safety Precautions



Ignoring this warning may result in death or serious injury.



Ignoring this warning may result in death or serious injury, and/or damage to the freezer and property.





Actions or operations which are prohibited



Actions or operations which must be followed

















 Warning

-  When CO₂/LN₂ backup is activated, the location place must be well ventilated. Increased CO₂ in the air may be harmful and even fatal. If the ventilation is poor, other methods should be considered in order to ensure safe working environments.
-  If there is a leakage of petroleum gas or other flammable gas, close the gas supply valve and open doors and windows to ventilate the air. Do not plug in or unplug your freezer unit in order to avoid potential explosion or fire.
-  Only professional technicians or service personnel can install the unit. Failure to do so may cause electric shock or result in a fire hazard.
-  The freezer must be securely installed on a firm floor. On an uneven surface may result in the product tipping over thereby causing injury and damage.
-  Please use the dedicated power supply marked on the product label to avoid fire and electric shock.
-  If the voltage being used is 10% higher than the rated voltage, a regulator with a capacity of 4000 W or higher must be installed.
-  If the power cord needs to be extended, the cross-section of the extended cable must be no less than 14Awg and no longer than 9ft for products of 220V~240V/50Hz or 220V~/60Hz and no less than 12Awg and no longer than 3m for products of 115V~/6Hz to avoid fire or electric shock.
-  Your ULT unit is equipped with a standard three-prong power plug (grounded) complying with the standard three-prong socket (grounded) rated 16 a (220V~240V/50Hz or 220V~/60Hz) or rated 20A (115V~/60Hz). Removal of the ground prong be securely plugged into the socket. A loose plug in the socket may cause fire.
-  The power socket intended for your ULT usage must be grounded to avoid electric shock. If the socket does not meet this requirement, the condition must be corrected by a qualified technician before using the UL unit.
-  The replacement of any spare parts (battery, etc.) shall be conducted by approved technicians.
-  Never install your ULT in an unprotected area. If the unit is exposed to moisture, there is a danger of electric shock.
-  Your ULT must not be installed in a damp area or an area subjected to water spray, as may reduce the degree of insulation and thereby cause electrical leakage or electrical shock.
-  Never directly pour water into the unit. The water may cause electrical shock or short circuit.

















-  Do not place heavy objects on top of the unit, as a falling object may cause injury.
-  Never use gas lines, water mains, telephone lines or lightning rods as the grounding device for you ULT unit. This type of improper grounding may cause electric shock or other danger.
-  Do not touch any electrical components, switches or power cord with wet hands. Such actions may lead to electric shock.
-  When unplugging the power cord from the socket, please grip the plug itself and pull it out. Do not pull on the power cord as this may strip the wires out of the plug thereby causing electric shock and fire.
-  Should there be any Malfunction in the equipment, power off the unit and unplug the power cord from the power supply. Continues operation in an abnormal condition may result in electric shock and fire.
-  User must not dismantle, repair or modify the equipment. Such operations may result in fire or personal injury.
-  Before any repair and maintenance of the freezer, please disconnect the power to avoid electric shock or injury to personnel.
-  When repairing and maintaining your freezer, take precautions not to inhale any chemicals or aerosols floating inside and outside the unit. They may be harmful to your health.
-  If poisonous, radioactive or other harmful materials need to be stored in the unit, the Equipment should be located in a safe zone. Improper use of the equipment with such materials may harm the environment or operator's health.
-  If the unit is not to be in use for a long period of time, make sure the power cord is unplugged. Deteriorated insulation of the power cord may lead to electric shock or fire.
-  The freezer needs to be disposed by specialized personnel.
-  Do not use nay unapproved electrical components with the freezer.
-  Never store flammable, explosive or volatile materials in the unit, nor use any flammable spray near the unit, as this may cause an explosion or fire.
-  Never store corrosive chemicals with acid or alkaline properties in the unit, as this can lead to damage to internal components of the unit.
-  Do not use any glass containers with the unit. These containers may crack at low temperatures and cause injury.



-  Do not climb on top of the unit or place any object on it. Falling equipment may cause injury or property damage.
-  Do not use any hard objects such as nails and wires in opening or gaps such as air ventilation ports. Accidental contact between a hard object and a moving part may result in electric shock or injury.
-  Do not use electrical appliances inside the compartments of the appliance unless they are recommended by the manufacturer.
-  The appliance must be positioned so that the plug is accessible.
-  The appliance must be placed on a solid and flat surface, or excessive vibration and noise may occur when the appliance is operating.
-  If your cabinet is to be discarded, you must remove the door and leave the shelves in place. This will reduce the possibility of danger.
-  If the supply cord is damaged, it must be replaced by the manufacturer, its service agent or similarly qualified persons in order to avoid a hazard.
-  Users must not dismantle, repair or modify the equipment. Such improper operations may result in fire or personal injury.
-  CP/IP foaming materials are flammable and require professional processing for disposal.
-  No modification of this equipment is allowed.
-  To avoid the risk of electric shock, this equipment must only be connected with a grounded supply.
-  There should be at least 12.5 in space between the surrounding walls and the freezer for ventilation.
-  Equipment cannot be run with increased levels of O₂, flammable gas or liquids.
-  After restarting your unit from a power outage or shutdown, ensure that all settings are correct. Accidental changes in settings may damage the stored products.
-  In the event of a power outage and recovery, wait for at least 5 minutes before turning the unit on again to avoid damage to compressors and refrigeration system.



-  The air filter for the condenser should be cleaned regularly. A dirty filter could cause a malfunction or the freezer temperature to rise.
-  During any repair operations, gloves should be worn to prevent getting injured by sharp edges or corners.
-  Do not use bare hands to directly handle any stored products. The cold temperature of products and the interior walls may cause frostbites.
-  Do not tilt the unit more than 45 degrees when moving it.
-  When moving the unit, please be cautious not to cause injury to personnel or damage the unit.
-  Do not attempt to use the handle to lift or move the unit to avoid damaging the freezer or injuring personnel.
-  Please open the lock first, then lift the handle.
-  Maximum weight per shelf is 50Kg/110lbs and weight of the entire unit should not Exceed 200kg/440lbs. Heavy loads may cause damage to the shelving system.
-  Keep ventilation openings, whether the appliance enclosure or built-in structure, clear Or obstructions.
-  Do not use mechanical devices or other means to accelerate the defrosting process, unless preapproved by the manufacturer.
-  Do not damage refrigerant circuit.
-  Unauthorized opening of the top cover of the control cabinet prohibited to prevent damage to the inside components or injury to the operator.
-  Turn the battery switch on before starting the unit; do not arbitrarily turn it off.
-  When the ULT unit has been placed in storage or not in use for a long time, its battery should be tested for low capacity because the battery may have already released all of its energy. Should this occur, please turn on the battery switch and run the unit for about a week to fully charge up the battery.



7.0 Usage Precautions

- When the unit operates normally, the unit frame at the front near the door may be slightly warm; This phenomenon is normal because hot tubing is embedded there to prevent condensation from forming on the frame.
- Before samples are loaded into the unit, make sure the unit temperature has reached the set point then load the samples into the freezer in batches. Each batch should not exceed 1/3 of the unit capacity, so that the temperature does not rise while samples are being loaded.
- The temperature display indicates the temperature from the sensor location inside the unit chamber, which may vary from the temperature at the center of the freezer but will gradually reach the actual temperature of the freezer over time.
- Two access ports are installed in the back wall of the unit which can be used as the pass-thru for thermocouple wires during testing and validation. Once all test wires are through the access port, make sure that the gap in the port is sealed properly with insulation materials. Failure to seal the access port may affect the operation of the unit. The port ring in the outer wall can also accumulate frost and ice.
- When cleaning the unit, mild or neutral detergent solution should be used. Never use a hard wire brush, acid, gasoline, powder detergent, polishing powder, or hot water to clean the freezer, as these tools and materials can damage the paint coating and plastic components. Never use gasoline or solution with volatile chemicals to clean plastic or rubber parts.
- After the freezer runs for some time, a layer of frost usually forms on the interior liner and inner doors. When this layer of frost becomes too thick, it can negatively impact the refrigeration performance of the unit. Energy consumption can increase. If the thickness reaches about .03 in / [5 mm], use the supplied scraper to remove the frost.
- Before removing the frost, temporarily transfer the stored samples to another freezer to prevent rising temperature from damaging the samples.
- Behind the interior walls, there are many refrigeration lines. Do not use a knife, an ice pick, or a screwdriver to cut ice and frost. This may damage not only the liner but also the refrigeration tubes.
- If the freezer is not in use for a period of time, turn off the power and backup battery.
The power cord should be unplugged.



Installation

8.0 Installation Environment

- Ambient temperature: 10°C to 32°C. The ideal temperature is 18°C to 25°C. If necessary, use an air-conditioning system to achieve the requires ambient condition.
- Environment humidity: less than 80% RH. At an environment of 32°C, humidity should be less than 57% RH.
- The intended location should be low in particulate count.
- The intended location should be vibration and shock free.
- Highest recommended elevation for safe usage: 2,000m above sea level.
- Input voltage: rated voltage \pm 10%.



- An ULT is sensitive to its operating environment. If a unit is not installed in the conditions mentioned above, it may not operate reliably.
- The unit is intended for indoor use only.



Do not dispose of electrical appliances as unsorted municipal waste, rather use separate collection facilities. Contact your local government for information regarding the collection systems available.



9.0 Installation Location

For the equipment to achieve optimal operating conditions, an intended installation location should satisfy the following requirements.

- Do not install the unit in a confined space. The doorway should be large enough for the unit to freely be transferred in or out of the room if necessary. This is to allow the unit to be repaired easily and timely to avoid damage to property.
- The location for installation should be flat and firm.
- There should be good ventilation and no direct sunlight.
- The freezer unit cannot share the same power socket with other equipment. The power plug should be securely connected to the power socket.
- The power cord for the freezer should not be twisted or pinched.
- If the power cord needs to be extended, the cross-section of the extended cable must not be no shorter than 2mm(14 gauge wire) and no longer than 3m(9.8ft).
- Before using the freezer, check the voltage supply. A voltage stabilizer to deliver rated voltage $\pm 10\%$ is recommended for areas in which the voltage is known to be unstable. The voltage stabilizer should be rated at least 4000W.
- The freezer must be grounded.
- If the power socket is connected with a ground terminal, make sure to inspect it for proper connection before using the equipment.



- Do not ground the freezer through gas lines, water mains, telephone lines and lightning rods, as this may lead to electric shock.
- After installation, the power plug must be easily accessible to unplug in case of an emergency. Nothing should block the ventilation port of the freezer.

10.0 Before Use Preparations

1. Remove packing materials and straps.

Remove all packing materials and straps for transportation.

2. Check the supplied accessories

Check the items in the packing box according to the packing list. If they do not match each other, please contact manufacturer.

3. Installation environment

These should be at least 12.5 in space between the surrounding walls and the freezer for ventilation.

4. Adjust Leveling legs

Rotated the leveling legs clockwise to extend them out to level the unit to the floor and ensure that the unit does not move while in use.

5. Placement

After adjusting and cleaning the unit, do not immediately connect the power cord. The freezer needs to be placed in its intended location for at least 24 hours before connecting the power to ensure it will operate normally.

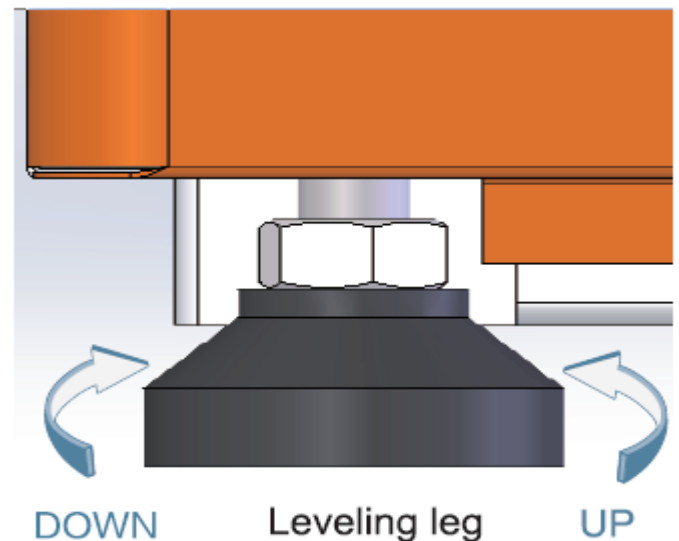
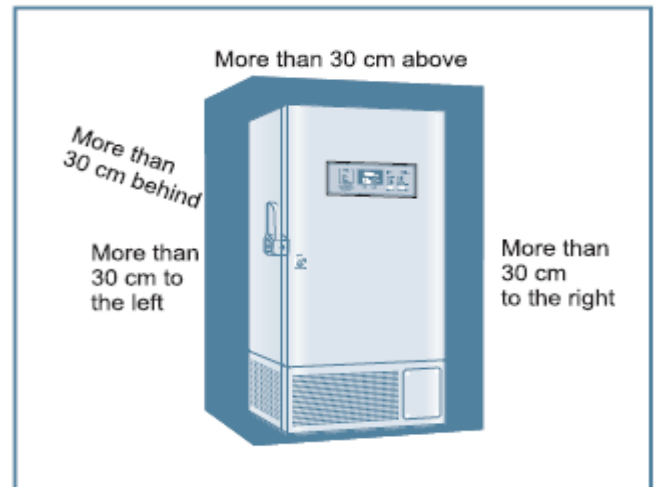

11.0 Initial Power

When the unit is started for the first time, please follow the procedures below.

1. While keeping the unit empty, plug in the power cord to dedicated power socket that meets all electrical requirements.
2. Connect the freezer to the power supply, turn on the power switch located on the side of the freezer (as in the illustration on the right), and then turn on the battery switch.
3. If the unit has a backup cooling system (optional) turn off the backup system.
4. Test the unit: Do not load the unit with any samples. Power up the unit to let it run down to -60°C . Let it run at -60°C for 8 hours then lower it to -80°C . Observe the unit performance for 24 hours for normal cycling to ensure that it is working properly.
5. Once the unit is confirmed to be operating properly, it is ready to be loaded with samples. Load the unit with samples in batches of less than 1/3 of the unit's capacity. Make sure that the unit is capable of cycling for more than 8 hours.
6. If the unit has a backup cooling system (optional), turn it on.

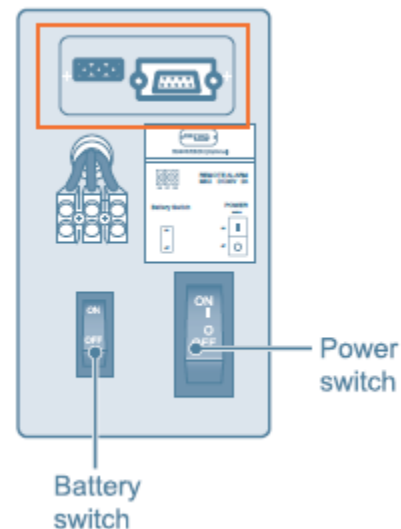



- Your ULT unit should be cared for by trained personnel. Every 2 to 4 hours, the Unit's working status should be inspected and recorded on a daily basis. Should there be a malfunction in the unit, the freezer temperature rises. If the problems cannot be corrected in a short time, please remove the stored samples, move them to another unit that meets the temperature requirements to avoid potential damage to samples.



- Before putting samples in the freezer to be stored, first check that the freezer's temperature is at the desired setpoint to prevent damage or loss.
- All ultra-low temperature storage units are low temperature storage equipment. It is not recommended to load excessive amounts of samples into the unit at one time. Overloading may result in inadequate performance. The freezer and the compressors can become overheated. Samples must be loaded in batches, while gradually decreasing temperature setting. The process should be repeated until the final temperature is reached.
- Do not use any unauthorized mechanical tools or other means to accelerate the defrosting process.
- Do not damage the refrigeration circuit.
- Do not use any unapproved electrical components in the freezer.

12.0 Operation after a Power Outage

Your ULT freezer control settings are stored in its memory system. Should there be power outage and recovery, the unit can resume its operation based on the previous settings.



- In the level of a power outage and recovery, be sure to wait for at least 5 minutes before turning the unit on again to avoid damaging the compressors and refrigeration system.
- If the unit is not in use for a long period of time, make sure the power cord is unplugged. Deteriorated insulation of the power cord may lead to electric shock or fire.



13.0 Freezer Parts

13.1 Vertical Type

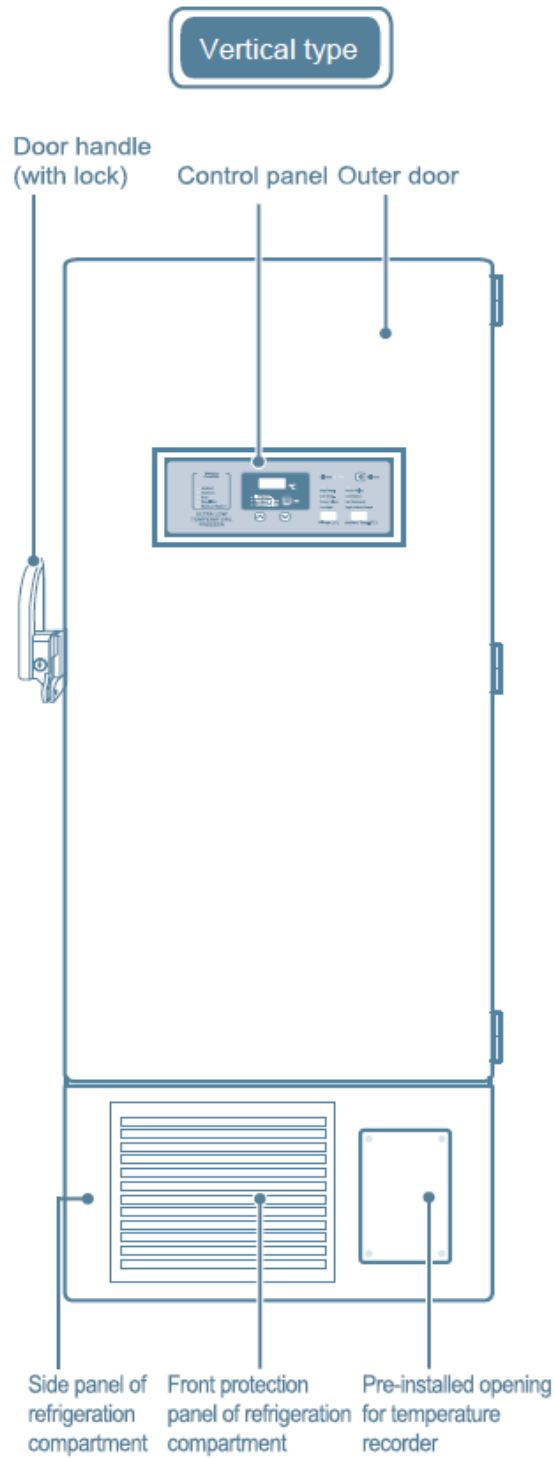



13.2 Horizontal type

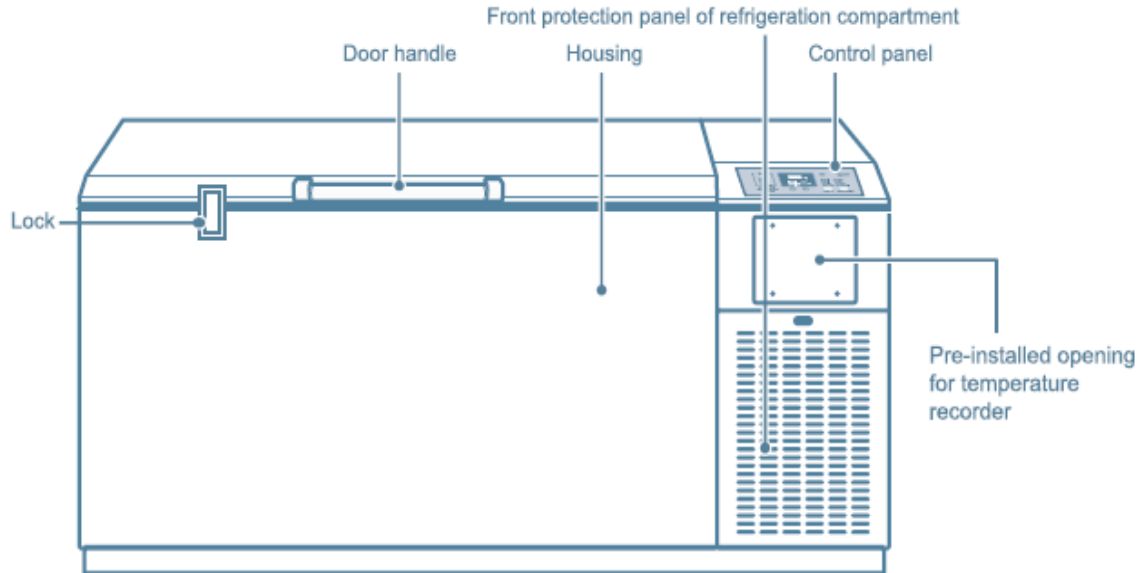

14.0 Control Panel

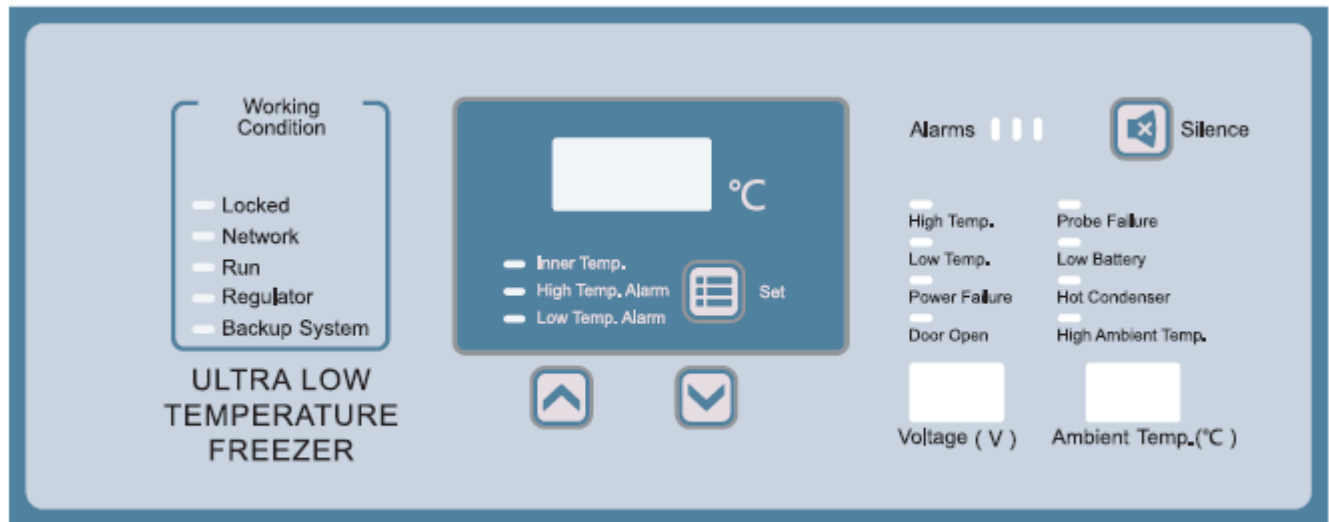

15.0 How to Use the Freezer

15.1 Unlocking the freezer

Before adjusting the settings, you must unlock the freezer.

1. Press "" or "" key, adjust the number to "06".
2. Press and hold "Set" key for 5 seconds; the "locked" indicator turns off. The unit is unlocked mode and can be set.
3. Press "Set" key again to select mode for setting the inner temperature, high temperature alarm and low temperature alarm; the corresponding indicator will light up as each function is selected.



15.2 Setting the inner temperature

1. Unlocked mode, press "Set" key to select "Inner Temp", the temperature display flashes and displays the setting value.
2. Then, press "" or "" key, adjust temperature setting value. Temperature setting range: -10 to -86°C. Recommended temperature setting range: -40 to -86°C.
3. Do not touch the unit for 10 seconds. After adjustment, the unit automatically enters into locked mode and the temperature display stops flashing, which means the value set has been entered into the computer. Otherwise, the setting is invalid.

For example: Set the inner temperature to -80°C.



4. After setting the inner temperature, the high temperature alarm and low temperature alarm will automatically adjust to proper values. If the user has special requirements, follow the steps below to adjust the values manually.



15.3 Setting the high temperature alarm

1. In unlock mode, press "Set" key to select "High Temp. Alarm", the temperature Display Flashes and display the setting value.
2. Press "" or "" key, adjust the high temperature alarm setting value. Temperature setting range: at least +5°C above the inner temperature.
3. Do not touch the unit for 10 seconds. After adjusting, the unit automatically enters into Locked mode and the temperature display stops flashing, which means the value set has been entered into the computer. Otherwise, the setting is invalid.

For example: If inner temperature is set to -80°C, setting the high temperature alarm to -75°C is recommended.





15.4 Setting the low temperature alarm

1. In unlocked mode, press "Set" key to select "low Temp. Alarm", the temperature Display flashes and display the setting value.
2. Then, press " or "" key, adjust the low temperature alarm setting value. Temperature setting range: above -91°C and at most -5°C below the inner temperature.
3. After adjusting, do not touch the unit for 10 seconds. The unit automatically enters into Locked mode and the temperature display stops flashing which means the value set has been input into the computer. Otherwise, the setting is invalid. For example: Set the low temperature alarm to -91°C.



15.5 Setting the security code





When used for the first time, the security code to unlock the control is set at "06".

1. In unlock mode, simultaneously press and hold "Set" key and "Silence" key for 5 seconds until the temperature display shows "06".
2. Then press " or "" key, adjust the security code. The choices are from 05 to 30.
3. After adjusting, do not touch the unit for 5 seconds. The unit automatically enters locked mode which means the setting is valid. (Note: please remember your code.) For example: Change the security code from 06 to 05.



15.6 Setting the startup timer

In order to reduce the startup power surge after a power outage, your ULT incorporates a startup delay feature, which can alter startup sequence of the compressors in the freezer.

1. In unlocked mode, simultaneously press and hold "Set" and " or "" key for 5 seconds, the temperature display shows the factory default value of the time delay "01" (1 minute).
2. Then, press " or "" key, adjust the value. The choices are from 01 to 10 (1 to 10 minutes are available). For example: Change the time delay from 1 minute to 5 minutes.



15.7 Alarm test and low battery test

1. In unlocked mode, simultaneously press and hold "Up arrow" key and "Silence" key for 5 seconds, the buzzer alarm sounds, and the alarm indicator flashes.
2. At this time the 6-second battery current test is initially implemented. If the battery capacity is low, the low battery indicator will flash 6 times. If the Battery capacity is normal, the indicator will not light up or flash. The choices are from 05 to 30.
3. After 6 seconds, the alarm test starts up. All indicators will light up for 6 seconds without flashing and all electric display Windows will indicate "8" for 6 seconds, which means all display functions are working properly.



15.8 Setting the USB storage time

1. In unlocked mode, press and hold "Up arrow" key for 3 seconds; the temperature display steadily shows "1P". ("1P/2P/3P/4P/5P" stands for "Years/Months/Days/Hours/Minuets", respectively)
2. Press 'Set' key, the temperature display shows years and flashes (default value: 10).
Press "Up arrow" or "Down arrow" key, select years. The choices are from 10 to 99. If you want to set the Year 2013, select 13.
Press "Set" key to save the changes; then, the temperature display steadily shows "2P".
Follow the procedure above to set "2P", "3P", "4P" and "5P" respectively, and press "Set" key to save the changes.
The temperature display will then show "1P" again, at which point you can reset 1P to 5P.
For example: Set the time as 08:30, August 16, 2019.
3. After the settings are completed, press and hold "Set" for 5 seconds; the changes will be Saved and exit the settings automatically. The temperature display will then normally show the inner temperature.

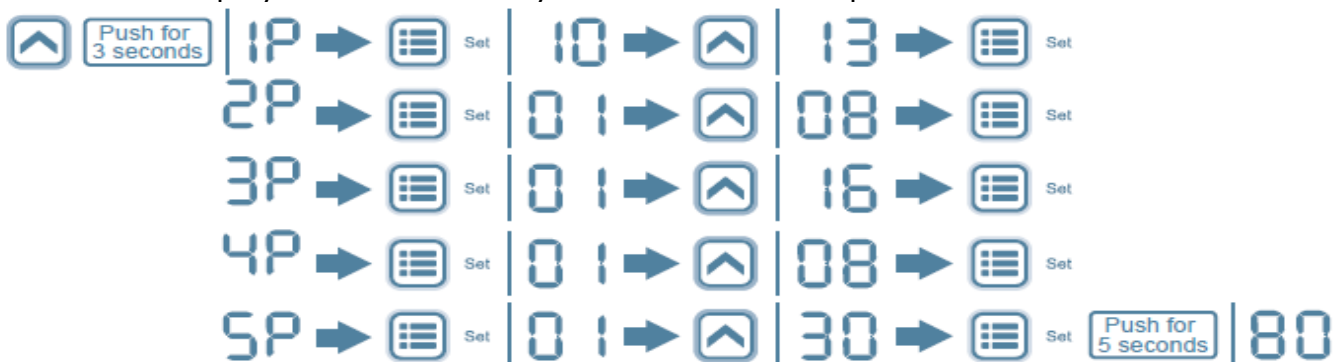



During the above procedure setting 1P to 5P, you can use "▲" or "▼" key to adjust the setting Individually.

For example: The temperature display shows 1P (Years), if you do not need to change Years (1P) and Months (2P), you can adjust Days (3P) directly.

1. Press "▲" key to select Days (3P).
2. Press "Set" key, the temperature display shows the date and flashes.
3. Press "▲" or "▼" key to adjust the current date.
4. Press "Set" key to save the change. Then, the temperature display will show Hours (4P).
5. If you need to adjust the Hours, press "Set" key to change the setting.

If no adjustments need to be made, press "▲" key; the display shows Minutes (5P), changes can then be entered.

6. After having finished the settings, press and hold "Set" for 5 seconds, the changes will be saved and the settings menu will be automatically exited from. The temperature display should show the inner temperature.



During the above procedure setting 1P to 5P and after finishing adjustment of any of the settings, and if no other settings need to be changed, you can press and hold "Set" key for 5 seconds to save the changes and exit the settings.

15.9 Exporting USB data

1. In unlocked mode, insert the USB flash drive. The temperature display USB, which means data is being exported.
2. When the temperature display shows ALL and exporting of the data is finished, Please remove the USB flash drive.



the system memory can save data for up to 10 years.



16.0 Display and Alarms

When the freezer is powered up and the power switch is turned on, the display will show the inner temperature, ambient temperature and current voltage.

Instructions on the display panel working conditions:

“Locked” indicator on: indicates all settings are locked to prevent erroneous operation.

“Network” indicator on: indicates the network is in working mode.

“Run” indicator on: indicates the compressors are in working mode.

“Regulator” indicator on: indicates the voltage stabilizer is in working mode to increase or decrease the voltage.

“Backup system” indicator on: indicates the backup cooling system is in working mode.

16.1 Alarms

Alarms	Alarm triggering conditions	Indicators	Buzzers
High temperature alarm	When this indicator is on, the unit temperature reaches the high temperature alarm limit.	Alarm indicator flashes.	15 min. delay then buzzer sounds intermittently (Note: delay of 3 hours following initial power up)
Low temperature alarm	When this indicator is on, the unit temperature reaches the low temperature alarm limit.		
Power failure alarm	Equipment loses power.	Alarm indicator flashes. Display shows temperature and blinks intermittently.	Buzzer delays 1 minute then sounds intermittently.
Excessive voltage alarm (some models)	Voltage exceeds the high or lower limits.	Alarm indicator flashes.	Buzzer delays 1 minute then sounds intermittently.
Dirty condenser alarm	Condenser filter element is clogged or the ambient temperature is too high.	Alarm indicator flashes.	Buzzer sounds intermittently.



High ambient temperature alarm	Ambient temperature is higher than 32°C and lower than 38°C .	Alarm indicator flashes.	—
	Ambient temperature exceeds 38°C.	Alarm indicator flashes.	Buzzer sounds intermittently.
Probe failure alarm	Main cabinet temperature control sensor fails.	Alarm indicator flashes. Display alternates (back and forth) between E2 and cabinet temperature.	Buzzer sounds intermittently.
	Condenser sensor fails.	Alarm indicator flashes. Display alternates (back and forth) between E1 and cabinet temperature.	Buzzer sounds intermittently.
	Ambient temperature sensor fails.	Alarm indicator flashes. Display alternates (back and forth) between E0 and cabinet temperature.	Buzzer sounds intermittently.
	Heat exchanger sensor fails.	Alarm indicator flashes. Display alternates (back and forth) between E3 and cabinet temperature.	Buzzer sounds intermittently.
Low battery alarm	Lower battery capacity or battery switch is not turned on.	During the battery test, the alarm indicator flashes.	—
Doors open alarm	The door remains open for more than 5 minutes.	Alarm indicator flashes.	Buzzer sounds intermittently.

 **Caution**

- A flashing alarm cannot be cancelled unless the malfunction is eliminated. The buzzing alarm can be temporarily silenced for 30 minutes by pressing the “Silence” key. However, if the problem persists, the buzzer alarm will resume after 30 minutes.
- When using the freezer, the battery switch must be turned on to charge the battery.
- When there is a power outage, the battery sustains the temperature display. If the battery voltage is insufficient, the temperature display will turn off.
- While the battery is still capable of providing power to display, the temperature display can be turned off by unplugging the power cord and turning off the battery control switch.
- The freezer is also designed to auto-adjust the inner temperature set point in high ambient temperatures. When the ambient temperature is warmer than 35°C and the set point temperature is set to be lower than -82°C, the set point temperature is equal to or cooler than 30°C, the set point will resume at the intended inner set point. This feature extended the life expectancy of the freezer.

16.2 Setting the buzzer alarm resumption time

- When the unit is in alarm mode, you may press the “Silence” key to stop the buzzing of the alarm (The remote alarm cannot be cancelled).
- If the condition persists, the buzzer alarm will resume automatically after 30 minutes.

16.3 Remote alarm terminals and RS232/485 terminals

- Remote alarm terminals are located on the control box on the right side of the unit. The alarm signals are delivered via the terminals. The terminals are rated for 30V DC t 2A.
- Terminal output: Remote alarm terminals consist of NC, NO and COM terminals. User can choose the Normal Open or Normal Close alarms as needed.
- RS232/485 terminals is standard for freezer.



17.0 Cleaning Freezer Parts



- To prevent electric shock or injury to operators, the AC power supply to the freezer must be disconnected completely prior to any repair and maintenance work is being performed.
- During any repair maintenance work, do not inhale sample particles or aerosols near the equipment as this may harmful.

17.1 Cleaning the freezer

- Clean the unit once a month.
- Use a dry cloth to wipe away loose dust inside and outside of the freezer. If the unit is dirty, use a clean cloth soaked with a neutral detergent solution. Using a dry cloth to wipe away any residual detergent solution.
- Do not pour water directly onto the exterior or into the interior of the unit. Water can damage the electrical insulation thereby causing a malfunction.
- Compressors and other mechanical parts are hermetically sealed. They do not need lubrication.
- Clean frost and ice off the unit once a month. Also, clean the condenser filter once a month.

17.2 Clean the condenser filter

When the cooler panel shows an alarm signal for “Hot Condenser”, the alarm light flashes. The filter still be cleaned once a month. If the filter is clogged, it will affect the refrigeration efficiency and reduce the product’s lifespan.

To clean the filter, follow the procedure below:

1. Remove the front grill cover.
2. Pull out the filter screen.
3. Use water to wash the filter screen.
4. After the filter screen is dry, reinstall It back in its original position and close the cover.
5. If the “hot Condenser” light is on before cleaning, check the light to make sure that it shuts off after cleaning. If it does not shut off, please contact service personnel.

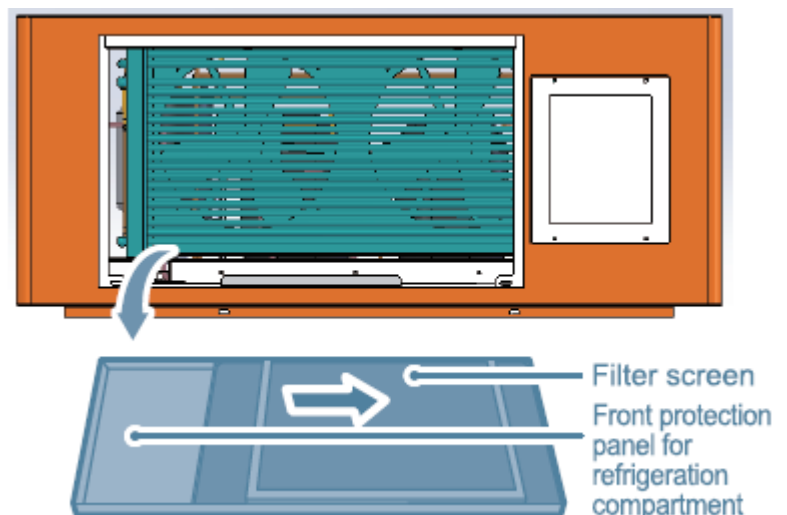



17.3 Defrost the interior

Frost and ice can form between the door gasket and frame to form an air gap, which can decrease the refrigeration effect of the unit. Use the provided plastic scraper to remove excess frost.

To defrost the unit, follow the procedure below:

1. Turn off any backup refrigeration system if applicable.
2. Remove the samples from the unit that need to be defrosted. Move them to another unit or a container for temporary storage.
3. Turn off the power supply.
4. Open the outer door and inner doors to let the unit thaw.
5. Use a dry cloth to soak up any water on the floor of the unit before restarting the unit.
6. Load the samples back into the unit after it reaches the set temperature.
7. Turn on the backup refrigeration system if present.



Do not use any sharp tools, such as knives or screwdrivers to defrost.

18.0 Recyclable and Rechargeable Battery

18.1 Battery maintenance

- If the battery capacity is low, please make sure the battery switch is turned on, and the battery will be charged. After about one week of charging, please recheck the battery capacity. If normal, the battery should be in full capacity; if the capacity is still low, replace the battery.
- The battery that supports the power outage alarm is a consumable item. The life expectancy for the battery is 2 to 3 years. If the battery is more than 3 years old, the battery should be replaced. To do so, please contact an Equipment and Instrument Service Center.

18.2 Disposal of the freezer



- Please keep out of children's reach.
- Disposal of the freezer should be carried out by professionals according to appropriate regulatory laws. The doors should be removed to prevent accidents, such as asphyxiation from accruing.
The freezer is equipped with a recyclable rechargeable battery.
When the battery reaches end of life, contact a local recycling organization to dispose of the battery.

18.3 Location of the battery

The battery is for the power outage alarm. It is located inside the control box on the right side of the unit.



There are high voltage components in the control box. To prevent electric shock, only a qualified technician or engineer should open the cover.

18.4 Removal of the battery

1. Turn off the unit and unplug the power cord from the socket.
2. Remove side panel by removing screws.
3. Use a screwdriver to remove the 4 screws on the cover of the control box.
4. Unplug the connecting terminals from battery.
5. Remove the bracket that fastens the battery. Then remove the battery.
6. Follow regulations to recycle or properly dispose of battery.



When changing the battery, make sure that the brown wire connects to the positive pole of the battery and that the blue wire connects to the negative pole of the battery.

The polarity must not be reversed. Incorrect polarity can damage the computer's motherboard and prevent the battery from being charged.

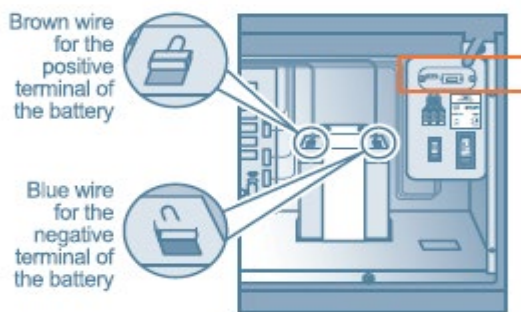

19.0 Optional Accessories

19.1 Temperature recorder

When using the temperature record, refer to the "User manual for temperature Record".



The temperature record should only be installed by professional technicians.



Before installing the temperature record, the unit should be unplugged to avoid electric shock or fire.

19.2 Co2 and LN2 backup cooling system

For installation and operation of the backup cooling system, please refer to the user's manual provided with the system.



Please purchase steel cylinders fitted with a siphon, the siphon can be used to siphon fluids that flow out from the bottom of the steel cylinders.



- The location of any equipment using CO₂/LN₂ must be in a well ventilated area. Increased CO₂ in the air may be harmful and even fatal. If the ventilation is poor, another method should be considered in order to ensure a safe working environment.
- CO₂/LN₂ cylinders should be adequately secured. Unsecured tanks may present a safety risk.
- The temperature of liquid CO₂/LN₂ is extremely low, which could cause frostbite. When replacing the cylinder, always wear appropriate personal protective equipment.

19.3 Storage racks and boxes

If the unit is used to store small samples, storage racks and boxes provide more efficient use of internal space.

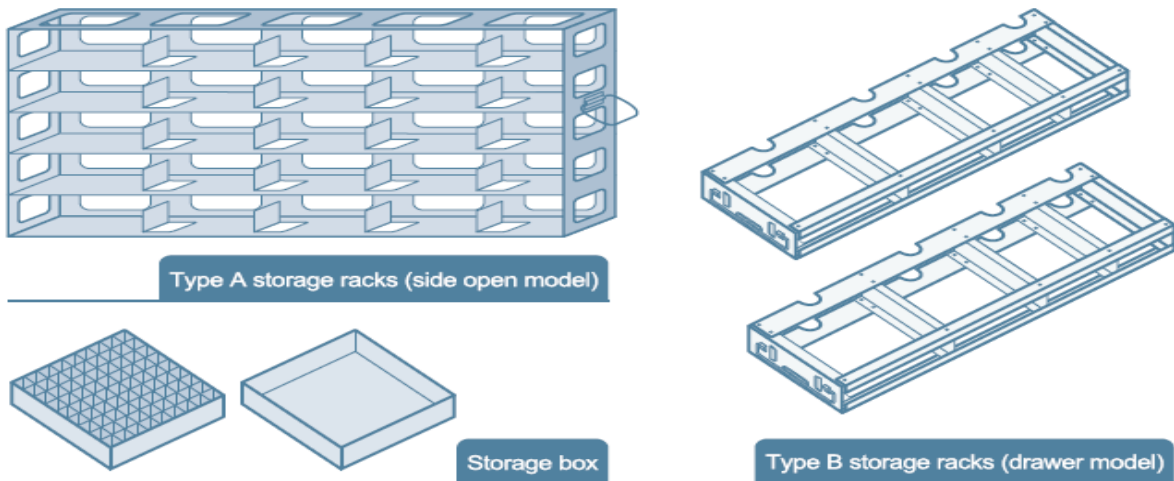

Model	Storage Rack (Type A/B are available)		Storage Box
	Variety	Amount	Amount
NU-99338JE/99338JG/99338JGA	4×4	6	96
	5×4	6	120
NU-99486JE	5×4	16	320
NU-99578JE/99578JG/99578JGA	5×5	16	400
NU-99728JE/99728JG/99728JGA	5×5	20	500
NU-99828JE/99828JG	5×5	24	600
NU-99420JE/420JG	11×1*	27	297

Note: Descriptions with an * mean that only type A storage racks are available. The storage racks and boxes may differ from the illustration above.



20.0 Troubleshooting

Malfunction phenomenon	Malfunction checks and resolutions
Freezer does not start up.	Is the power supply on? Has the main power switch been turned on?
	Is the voltage supply too low?
	Is there any voltage input from the outside?
Poor refrigeration effect.	Is the ambient temperature too high?
	Are the inner doors and outer doors closed properly? (Has any ice or frost damaged the seals between the door and the frame?)
	Is the condenser filter clogged?
	Is the temperature setting correct?
	Is the freezer being kept away from direct exposure to sunlight?
	Is the freezer near any heat source?
	Is the porthole plug installed in the porthole with proper insulation materials?
	Has the freezer been loaded with samples within the last few hours?
The unit is noisy.	Is the unit set on a firm and level floor?
	Is the exterior of the unit touching any objects?
	Is the freezer unit leveled with the leveling legs?



21.0 Refrigeration and Wiring Diagrams

21.1 Refrigeration diagram

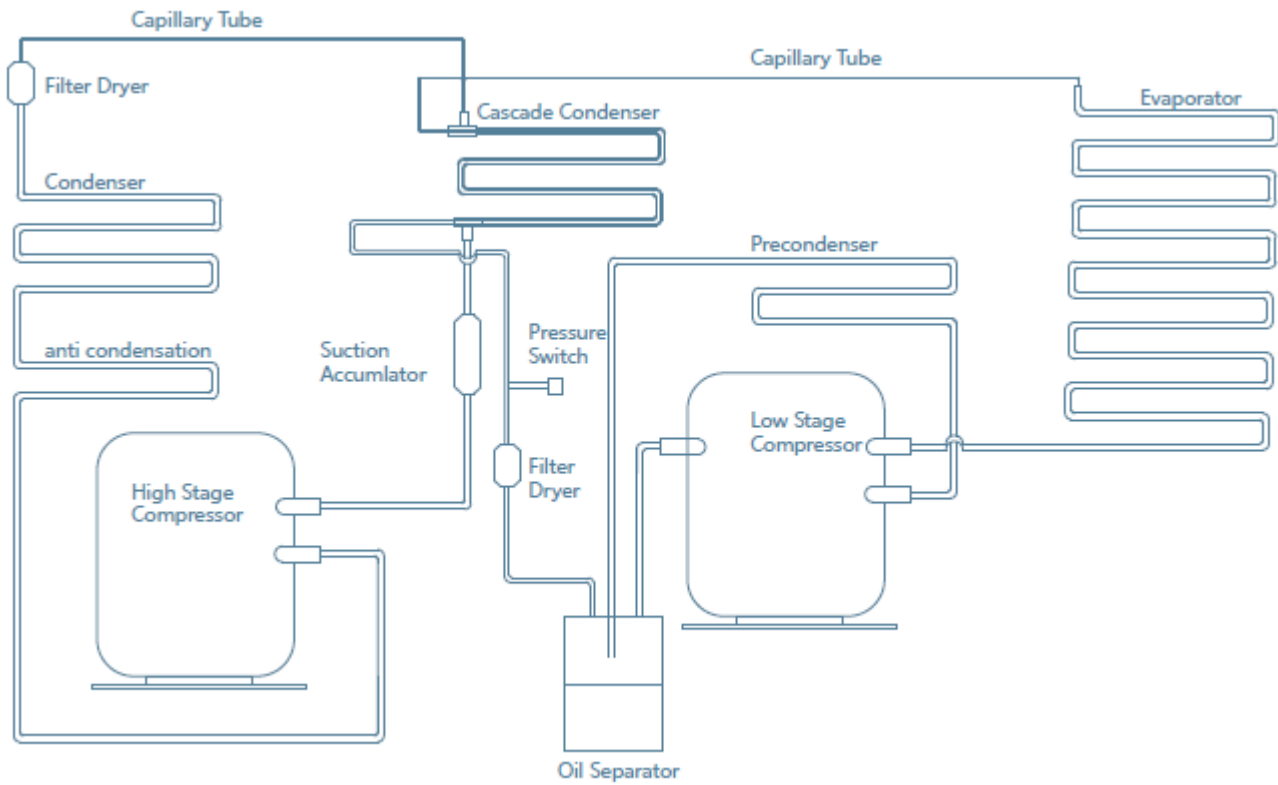



21.2 Wiring Diagram

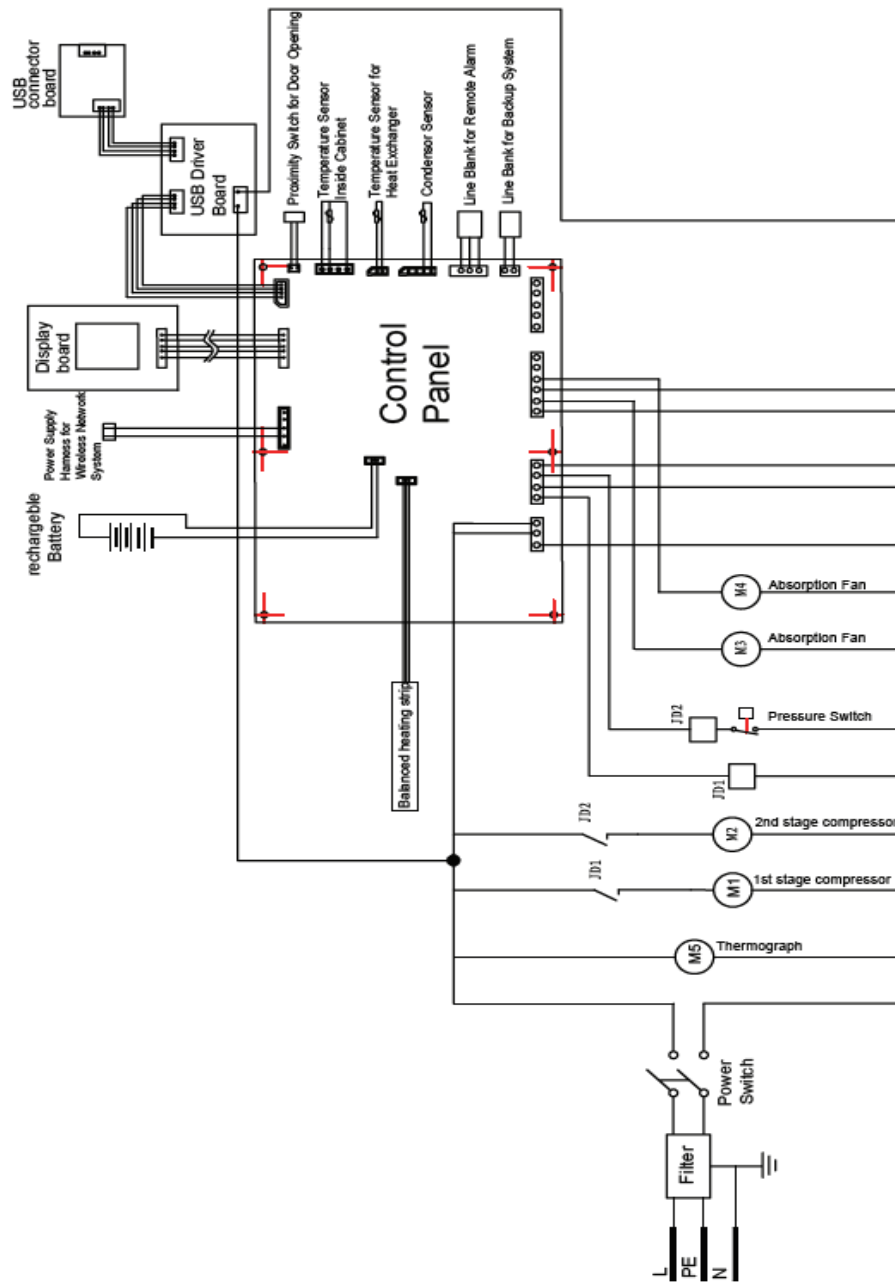



22.0 Specifications, Technical Data, and Packing List

22.1 Specifications

Product name	Ultra Low Temperature Freezer
Model	NU-99338JE/99486JE/99578JE/99728JE/99828JE/99420JE NU-99338JGA/99578JGA/99728JGA/99338JG/ NU-99578JG/99728JG/99828JG/99420JG
Exterior/interior wall material	Coated cold rolled steel
Outer doors	Coated cold rolled steel
Inner doors	Aluminum framed PS board
Shelves	Stainless steel shelves (height adjustable)
Porthole for testing	2
Insulation	Vacuum insulated with polyurethane foam (non-CFC)
Compressors	High stage: hermetically sealed Low stage: hermetically sealed
Evaporator	Copper tube
Condenser	Finned coil
Refrigerant	R290 R170
Temperature controller	Microprocessor controller
Temperature display	Digital display
Temperature sensor	RTD (Pt100)
Alarm device	High/low temperature alarm, probe failure alarm, hot condenser alarm, ambient temperature alarm, low battery alarm and Door open alarm
Battery at remote alarm terminals	Maximum load: 30 V DC, 2 A Rechargeable battery: 12 V DC, charges automatically
Electric shock protection type	I
Power supply connection type	Y
Ambient temperature	10°C to 32°C
Freezer temperature	-40°C to -86°C
Foaming Cabinet	CP/IP
USB	Standard



22.2 Technical Data

Model	Volume (L)	Rated Voltage (VAC)	Rated Frequency (Hz)	Rated Current (A)	Stable Current (A)	Power (W)	Weight (kg)	Dimensions (W x D x H) (mm)
NU-99338JG	338	220	60	7.5	7.0	1540	238	812 x 893 x 1846
NU-99338JE	338	230	50	7.5	4.0	920	238	812 x 893 x 1846
NU-99338JGA	338	115	60	18.0	6.8	935	238	812 x 893 x 1846
NU-99420JG	420	220	60	7.5	7.0	1540	310	2130 x 870 x 1020
NU-99420JE	420	230	50	7.5	7.0	1540	310	2130 x 870 x 1020
NU-99578JG	578	220	60	9.0	7.0	1540	300	895 x 980 x 1960
NU-99578JE	578	230	50	9.0	7.0	1540	300	895 x 980 x 1960
NU-99578JGA	578	115	60	18.0	8.1	935	300	895 x 980 x 1960
NU-99728JG	728	220	60	9.0	7.5	1650	345	1041 x 980 x 1980
NU-99728JE	728	230	50	9.0	7.5	1650	345	1041 x 980 x 1980
NU-99728JGA	728	115	60	18.0	8.1	935	345	1041 x 980 x 1980
NU-99828JG	828	220	60	10.0	7.5	1650	7.5	1145 x 980 x 1980
NU-99828JE	828	230	50	10.0	7.5	1650	7.5	1145 x 980 x 1980

22.3 Packing List

Model	User Manual	Instruction Install to Set Bolts	Plastic bag	Ice scraper	Key	Position limiter
NU-99338JE/338JG/338JGA	1	1	1	1	4	2
NU-99486JE	1	1	1	1	4	2
NU-99578JE/578JG/578JGA	1	1	1	1	4	2
NU-99728JE/728JG/728JGA	1	1	1	1	4	2
NU-99828JE//828JG	1	1	1	1	4	2
NU-99420JE/420JG	1	/	1	1	/	/