



NUAIRE BLIZZARD ULTRA LOW TEMPERATURE VARIABLE FREQUENCY TOUCHSCREEN FREEZER

NU-99729VFT

OPERATION & MAINTENANCE MANUAL



OM0299
Series A
Revision 2
April 2022



NuAire, Inc.
2100 Fernbrook Lane
Plymouth, MN 55447
Toll-Free: 1-800-328-3352
Minnesota: (763) 553-1270
Fax: (763) 553-0459

Table of Contents

1.0	Packing List	3
2.0	Precautions for Safe Operation	3
2.1	Safety Labels and Precautions	3
2.2	Precautions for Safe Operation.....	4
3.0	Product Features	7
4.0	Usage Precautions	8
5.0	Product Installation	10
5.1	Installation Environment.....	10
5.2	Installation Site	10
5.3	Preparation Before Use.....	11
5.4	Initial Startup.....	12
5.5	Operation after a Power Outage	13
6.0	Refrigerator Components	14
6.1	Control Panel.....	14
7.0	Operation	15
7.1	Homepage	15
7.2	Settings.....	16
7.3	Graph	23
7.4	Inquiry	24
7.5	Message	29
7.6	Alarm.....	31
8.0	Cleaning Maintenance	31
8.1	Cleaning the Freezer	32
8.2	Cleaning the Condenser Filter.....	32
8.3	Defrosting.....	32
8.4	Battery Maintenance	33
8.5	Disposal of Freezer.....	33
8.6	Disposal of Battery.....	33
9.0	Optional Accessories	34
9.1	Temperature Recorder.....	34
9.2	LCO2 Backup Cooling System.....	34
9.4	Electromagnetic Lock.....	35
9.5	Frozen Storage Racks and Storage Boxes	36
10.0	Troubleshooting	37
11.0	Refrigeration and Wiring Diagram	38
11.1	Refrigeration Diagram.....	38
11.2	Wiring Diagram	39
12.0	Specifications and Technical Data	40
12.1	Specification Table	40
12.2	Technical Data.....	41
12.3	Global Warming Potential.....	41

1.0 Packing List

Item	Quantity
Installation and Commissioning Manual	1
User manual/Spacer Installation Methods	1/1
Plastic bag	1
Ice scraper	1
Key	4
Spacer	2

2.0 Precautions for Safe Operation

Thank you for choosing a Nuaire Ultra Low Temperature (ULT) Freezer. Please read this manual for safe operation of this product.

2.1 Safety Labels and Precautions



Warning



Electric Shock



Watch Your Fingers and Hands







Combustible Materials



Low Temperature



Slippery Surface

 The upper and lower limits of temperature shall be indicated adjacent to the upper and lower horizontal lines.	 Symbol for "Manufacture"
 Symbol for "Consult instructions for use"	 Symbol for "Date of Manufacture"
EC REP European Authorized Representative	Elscolab BV. Tolboomweg 10, 3784 XC Terschuur, the Netherlands



Wear Cryogloves before opening the door.



No sitting



Grounding mark



Complied with the requirements of MDD 93/42/EEC annex V

2.2 Precautions for Safe Operation

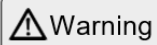

Warning

Failure to observe WARNING signs could result in a hazard to personnel possibly resulting in serious injury or death.

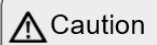

Caution

Failure to observe CAUTION signs could result in injury to personnel and damage to the unit and associated property.



Actions or operations which are prohibited



Actions or operations which must be followed

- ❗ When the CO₂/LN₂ backup system is activated, the installation place must be well ventilated. Increased CO₂ in the air may be harmful and even fatal. If the ventilation is poor, other methods should be considered to ensure safe working environments.
- ❗ If there is a leakage of petroleum gas or other flammable gas, close the gas supply valve and open doors and windows to ventilate the air. Do not plug or unplug your freezer unit to avoid potential explosion or fire.
- ❗ Only professional technicians can install the unit. Failure to do so may cause electricity or fire.
- ❗ The freezer must be securely installed on a firm floor. Tilted installation may result in the product tipping over, causing injury and damage.
- ❗ Only use a dedicated power supply matching the requirement specified on the label to avoid fire and shock.
- ❗ If the voltage being used is 10% higher than the rated voltage, a regulator with a capacity of 4000 W or higher must be installed.
- ❗ If the power cord needs to be extended, the cross-section of the extended cable must be no less than 2 mm² and no longer than 3 m for products of 208V~230V/50Hz or 208V~230V/60Hz and no less than 3 mm² and no longer than 3 m for products of 115V~/60Hz to avoid fire or electric shock.
- ❗ Your ULT unit is equipped with a standard three-prong power plug (grounded) complying with the standard three-prong socket (grounded) rated 16 A (208V~230V/50Hz or 208V~230V/60Hz) or rated 20A (115V~/60Hz). Removal of the ground prong is strictly prohibited for safety reasons under any circumstances. The electrical power plug should be securely plugged into the socket. A loose plug in the socket may cause fire.
- ❗ The power socket intended for your ULT usage must be grounded to avoid electric shock.
- ❗ If the socket does not meet this requirement, the condition must be corrected by a qualified technician before using the ULT unit.
- ❗ Replacement of any spare parts should be performed by qualified technicians.
- ⊘ Never install your ULT in an unprotected area. If the unit gets wet, there is a danger of electric shock.
- ⊘ Your Blizzard ULT must not be installed in a damp area or an area subjected to water spray. Otherwise this may reduce the degree of insulation which may cause electrical leakage or electrical shock.
- ⊘ Never directly pour water into the unit. The water may cause electric shock or short circuit.
- ⊘ Do not place any water container or heavy object on top of the unit. A falling object may injure an operator. If the water spills into the unit, it may damage the insulation thereby causing electric shock.
- ⊘ Never use gas lines, water mains, telephone lines or lightning rods as the grounding device for your ULT unit. This type of improper grounding may cause electric shock or other danger.
- ⊘ Do not touch any electrical components, switches, or power cord with wet hands. This may lead to electric shock.
- ❗ When unplugging the power cord from the socket, please grip the plug itself and pull it out. Do not pull the power cord as this may strip the wires out of the plug thereby causing electric shock and fire.
- ❗ Should there be any malfunction in the equipment, power off the unit and unplug the power cord from the power supply. Continuous operation in an abnormal condition may result in electric shock and fire.
- ⊘ Never disassemble, repair, or modify the unit yourself. Any such work carried out by an unauthorized person may result in fire, or electric shock or injury due to a malfunction.
- ❗ Before any repair and maintenance of the freezer, please disconnect the power to avoid electric shock or injury to personnel.

- ⓘ When repairing and maintaining your freezer, take precautions not to inhale any chemicals or aerosols floating inside and outside the unit. This may be harmful to your health.
- ⓘ If poisonous, radioactive, or other harmful materials need to be stored in the unit, the equipment should be located in a safe zone. Improper usage of the equipment with such materials may harm the environment or operator's health.
- ⓘ If the unit is not in use for a long period of time, make sure the power cord is unplugged. Deteriorated insulation of the power cord may lead to electric shock or fire.
- ⓘ If the unit is to be stored unused in an unsupervised area for an extended period, ensure that doors are locked completely with a key to prohibit unauthorized access.
- ⓘ The disposal of the unit should be accomplished by appropriate personnel. The doors should be removed prior to disposal.
- ⓘ Do not use any non-manufacturer approved electrical components in the freezer.
- ⓘ Never store flammable, explosive or volatile materials in the unit and do not use any flammable spray near the unit, as this may cause an explosion or fire.
- ⓘ Never store corrosive chemicals with acid or alkaline properties in the unit as this can cause damage to internal components of the unit.
- ⓘ Do not place any glass container or enclosed container into the freezer. These containers may crack at low temperatures causing injury to operators
- ⓘ Do not put the packing plastic bag within reach of children as suffocation may result.
- ⓘ Do not climb on top of the unit or place any object on it. Falling equipment may cause injury or property damage.
- ⓘ Do not use any hard objects such as nails and wires to explore any openings or gaps such as air ventilation ports. Accidental contact between a hard object and a moving part may result in electric shock or injury.
- ⓘ Do not use electrical appliances inside the chamber of the appliance unless they are recommended by the manufacturer.
- ⓘ The appliance must be positioned so that the plug is accessible.
- ⓘ The power plug is used as the disconnecting device.
- ⓘ The appliance must be placed on a solid and flat surface, or excessive vibration and noise may be produced when the appliance in operation.
- ⓘ If the power cord is damaged, it must be replaced by a qualified technician to avoid an electrical hazard.
- ⓘ To avoid the risk of electric shock, this equipment must only be connected to a supply main with protective ground.
- ⓘ There should be at least 1 ft (30 cm) space between the surrounding walls and the freezer for ventilation.
- ⓘ Equipment cannot run in the condition of rich O₂ and flammable gas or liquid.
- ⓘ After restarting your unit from a power outage or shutdown, ensure that all settings are correct. Accidental changes in settings may damage the stored products.
- ⓘ In the event of a power outage and recovery, be sure to wait for at least 5 minutes before turning the unit on again to avoid damage to the compressors and refrigeration system.
- ⓘ The air filter for the condenser should be cleaned regularly. A dirty filter could cause a malfunction or the freezer temperature to rise.
- ⓘ During any repair operations, gloves should be worn to prevent getting injured by sharp edges or corners.
- ⓘ Do not use bare hands to directly handle any stored products. The cold temperature of the products and the interior walls may cause frostbite.
- ⓘ Hold firmly onto the handle to close the door to avoid pinching your hands.
- ⓘ Do not tilt the unit more than 45 degrees when moving the unit.
- ⓘ When moving the unit, make a clear path to avoid injury to personnel and damage to the unit.
- ⓘ Do not attempt to use the handle to lift or move the unit to avoid damaging the freezer or injuring personnel.
- ⓘ Maximum loading on each shelf should be no more than 100 Lbs. (50 kg) and total loading for whole unit should be no more than 400 Lbs. (200 kg). Heavier loads may cause damage to the shelving system.

- ⓘ Keep ventilation openings, in the appliance enclosure or in the built-in structure, clear of obstructions.
- ⓘ Do not use mechanical devices or other means to accelerate the defrosting process.
- ⓘ Do not damage the refrigerant circuit.
- ⓘ Unauthorized opening of the top cover of the control cabinet is prohibited to prevent damage to the inside components or injury to the operator.
- ⓘ Turn the battery switch on before starting the unit, do not arbitrarily turn it off.
- ⓘ When the ULT unit has been placed in a storage or not in use for a long time, the battery should be tested for low capacity because the battery may have already fully discharged. Should this occur, turn on the battery switch and run the unit for about a week to fully charge up the battery.

3.0 Product Features

This product is suitable for the ultra-low temperature storage of products in applications such as clinical, pharmaceutical, scientific research, and epidemic institutions. It also can be used in blood stations, hospitals, centers for disease prevention and control, science and research institutions, electronic and chemical laboratories, biomedical engineering institutions, and open sea fishery companies to store red blood cells, viruses, germs, skin, bones, bacteria, sperm, biological products, electronic components, and low temperature testing samples of special products, etc.

- Temperature control
 - Temperature is controlled by computer and numerically displayed and regulated in units of 0.1°C; temperature range: -40°C to -86°C.
- Safety system
 - Various malfunction alarms (high/low temperature alarm, power failure alarm, probe failure alarm, hot condenser alarm, high ambient temperature alarm, door ajar alarm, low battery alarm).
 - Two types of alarms: Audible (buzzer sound) and Visual (flashing light).
 - Multiple levels of protection are standard including passcode and time-delayed start.
 - All components are electrically grounded.
- Refrigeration system
 - Optimized multiple refrigeration technology with top brand frequency compressors offering better refrigeration capability.
 - Excellent temperature preservation layer providing optimal temperature preservation effect.
 - Exclusive sealing structure of multiple doors and hot tubing for condensation prevention can reduce the frost effectively.
- Ergonomic design
 - Touchscreen display to indicate freezer temperature, ambient temperature, and input voltage. Control panel to set the high/low temperature alarm and inner temperature. All malfunction alarms are also shown on the display.
 - Designed with adjustable shelves, suitable for product storage.
 - Safety lock design prevents accidental opening of doors.
 - Installation in broad range of ambient temperature range of 10 °C to 32 °C environment.
 - Unique all-in-one latch design and compact caster features allow ease of operation and maneuvering.
 - Condensing fan motors are automatically controlled to turn on and off for energy saving.
 - Network and remote alarm contacts are available for convenient connection and communication.

NOTE: Not all models have all features mentioned above. For specific features, please refer to the specification table of each specific model. Due to the product improvement, the Nuaire ULT Freezer you get may not be completely consistent with the illustration in the manual. The contents of this manual are subject to changes without notice.

4.0 Usage Precautions

- While the unit is operating, the door frame will become slightly warm. The embedded hot gas halo tube provides latent heat to prevent condensation to form on the door frame.
- Before samples are loaded into a freezer, make sure the unit has reached the set temperature. Samples should be loaded into the freezer in batches. Each batch should be no more than 1/3 of the freezer capacity. This process allows the freezer to pull down the temperature in a reasonable time without damaging the compressor.
- The temperature display indicates the temperature where the temperature sensor is mounted inside the unit chamber, which may vary from the temperature at the center of the freezer, but it will gradually reach the actual temperature of the freezer over time.
- Two access ports are available for testing in the back of the freezer. Thermocouple wires can go through the port holes to reach the interior of the freezer for temperature mapping. The gap of the holes should be sealed with insulation materials so that the interior temperature is not influenced by the ambient temperature.
- When cleaning the unit, mild and neutral detergent solution should be used. Never use a hard wire brush, acid, gasoline, detergent powder, polished powder or hot water for cleaning. These tools and materials can damage the paint and coating of the unit. Particularly, never use gasoline or a solution with volatile chemicals to clean plastic or rubber parts.
- After the freezer runs for some time, a layer of frost usually forms on the interior wall and inner doors. When the frost gets too thick, the refrigeration effect can be impaired. Energy consumption will increase. If the thickness reaches 3/16" (5 mm), please use the supplied scrapper to remove the frost.
- Before removing the frost, temporarily transfer the stored samples to another freezer. This is so that the temperature does not rise in the unit and damage the samples.
- Behind the interior walls, there are many refrigeration tubes. Do not use a knife, an ice pick, or a screwdriver to cut ice and frost. This may damage not only the liner but also the refrigeration tubes.
- If the freezer is not in use for a long time, please turn off the power and switch off the backup battery. The power cord should be unplugged.
- Federal Communications Commission (FCC) Interference Statement
 - This equipment has been tested and found to comply with the limits for a Class B digital device, pursuant to Part 15 of the FCC Rules.
 - These limits are designed to provide reasonable protection against harmful interference in a residential installation. This equipment generates, uses and can radiate radio frequency energy and, if not installed and used in accordance with the instructions, may cause harmful interference to radio communications.
 - However, there is no guarantee that interference will not occur in a particular installation. If this equipment does cause harmful interference to radio or television reception, which can be determined by turning the equipment off and on, the user is encouraged to try to correct the interference by one of the following measures:
 - Reorient or relocate the receiving antenna.
 - Increase the separation between the equipment and receiver.
 - Connect the equipment into an outlet on a circuit different from that to which the receiver is connected.
 - Consult the dealer or an experienced radio/TV technician for help.
- This device complies with Part 15 of the FCC Rules. Operation is subject to the following two conditions:
 1. This device may not cause harmful interference
 2. This device must accept any interference received, including interference that may cause undesired operation.

FCC Caution: Any changes or modifications not expressly approved by the party responsible for compliance could void the user's authority to operate this equipment.

- RF exposure warning

This equipment complies with FCC radiation exposure limits set forth for an uncontrolled environment. This equipment must be installed and operated in accordance with provided instructions and the antenna(s) used for this transmitter must be installed to provide a separation distance of at least 20 cm from all persons and must not be collocated or operating in conjunction with any other antenna or transmitter.

This equipment complies with ISED RSS-102 radiation exposure limits set forth for an uncontrolled environment. This equipment should be installed and operated with a minimum distance of 20cm between the radiator and any part of your body.

Pour se conformer aux exigences de conformité CNR 102 RF exposition, une distance de séparation d'au moins 20 cm doit être maintenue entre l'antenne de cet appareil et toutes les personnes.

Contains FCC ID: 2ASR8NFCV3, 2ASR8SC3832.

This device contains licence-exempt transmitter(s)/receiver(s) that comply with Innovation,

Science and Economic Development Canada's licence-exempt RSS(s). Operation is subject to the following two conditions:

1. This device may not cause interference.
2. This device must accept any interference, including interference that may cause undesired operation of the device.

L'émetteur/récepteur exempt de licence contenu dans le présent appareil est conforme aux CNR d'Innovation, Sciences et Développement économique Canada applicables aux appareils radio exempts de licence. L'exploitation est autorisée aux deux conditions suivantes :

1. L'appareil ne doit pas produire de brouillage;
2. L'appareil doit accepter tout brouillage radioélectrique subi, même si le brouillage est susceptible d'en compromettre le fonctionnement.



Do not dispose of electrical appliances as unsorted municipal waste, use separate collection facilities. Contact your local government for information regarding the collection systems available.

5.0 Product Installation

5.1 Installation Environment

- Ambient temperature: 10°C to 32°C. The ideal temperature is 18°C to 25°C. If necessary, use an air-conditioning system to achieve the requires ambient condition.
- Environment humidity: less than 57% RH.
- Installation area should be clean and free from large amounts of dust.
- Installation area should be free from vibration and shocks.
- Highest recommended elevation for safe usage: 2,000 m above sea level.
- Input voltage: rated voltage \pm 10%.



- An ULT is sensitive to its operating environment. If the unit is not installed in the conditions mentioned above, it may not operate reliably.
- The unit is intended for indoor use only. Improper use may result in damage to the unit or injury.

5.2 Installation Site

For the equipment to achieve optimal operating conditions, an intended installation location should satisfy the following requirements.

- Do not install the unit in a confined space. The doorway should be large enough for the unit to freely be transferred in or out of the room if necessary. This is to allow the unit to be repaired easily and timely to avoid damage to property.
- The location for installation should be flat and firm.
- There should be good ventilation and no direct sunlight.
- The freezer unit cannot share the same power socket with other equipment. The power plug should be securely connected to the power socket.
- The power cord for the freezer should not be twisted or pinched.
- If the power cord needs to be extended, the cross-section of the extended cable must not be no shorter than 2 mm (14 gauge wire) and no longer than 10 ft [3 m].
- Before using the freezer, check the voltage supply. A voltage stabilizer to deliver rated voltage \pm 10% is recommended for areas in which the voltage is known to be unstable. The voltage stabilizer should be rated at least 4000W.
- The freezer must be grounded.
- If the power socket is connected with a ground terminal, make sure to inspect it for proper connection before using the equipment.

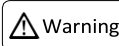

- Do not ground the freezer through gas lines, water mains, telephone lines and lightning rods, as this may lead to electric shock.
- After installation, the power plug must be easily accessible to unplug in case of an emergency. Nothing should block ventilation port of the freezer.

5.3 Preparation Before Use

1. Remove packing material and straps.
2. Check the supplied accessories
 - Check the items in the packing box according to the packing list. If anything does not match, contact Nuaire support immediately.
3. Placement
 - This freezer is for **indoor** and **dry conditions only**.
 - Reserve at least 1 ft [30cm] of clearance on each side of the freezer for proper ventilation.



4. Adjust Levelling Legs
 - Rotate the levelling legs clockwise to extend them to level the unit.

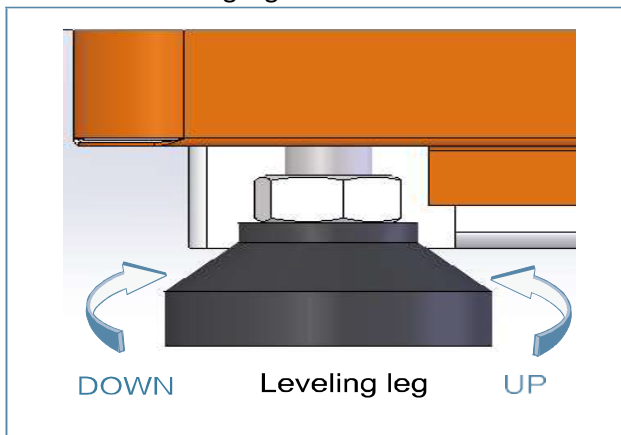

5. Acclimation Period
 - After adjusting and cleaning the unit, do not turn on the power. **The freezer needs to acclimate to its surroundings for at least 24 hours** to ensure proper operation.



- To handle the freezer before unpacking, forklift or package carrier may be used. If the forklift is used, it shall be inserted at the bottom of blocking from the front or back of the freezer to move the freezer. If the package carrier is used, it shall pick up at the bottom of blocking and can only pick up the side of the freezer.
- After unpacking, you may push wheels for maneuvering.
- During handling, do not tip the freezer at more than 45° to avoid tipping.

5.4 Initial Startup

When powering on the unit for the first time, follow the procedures below:

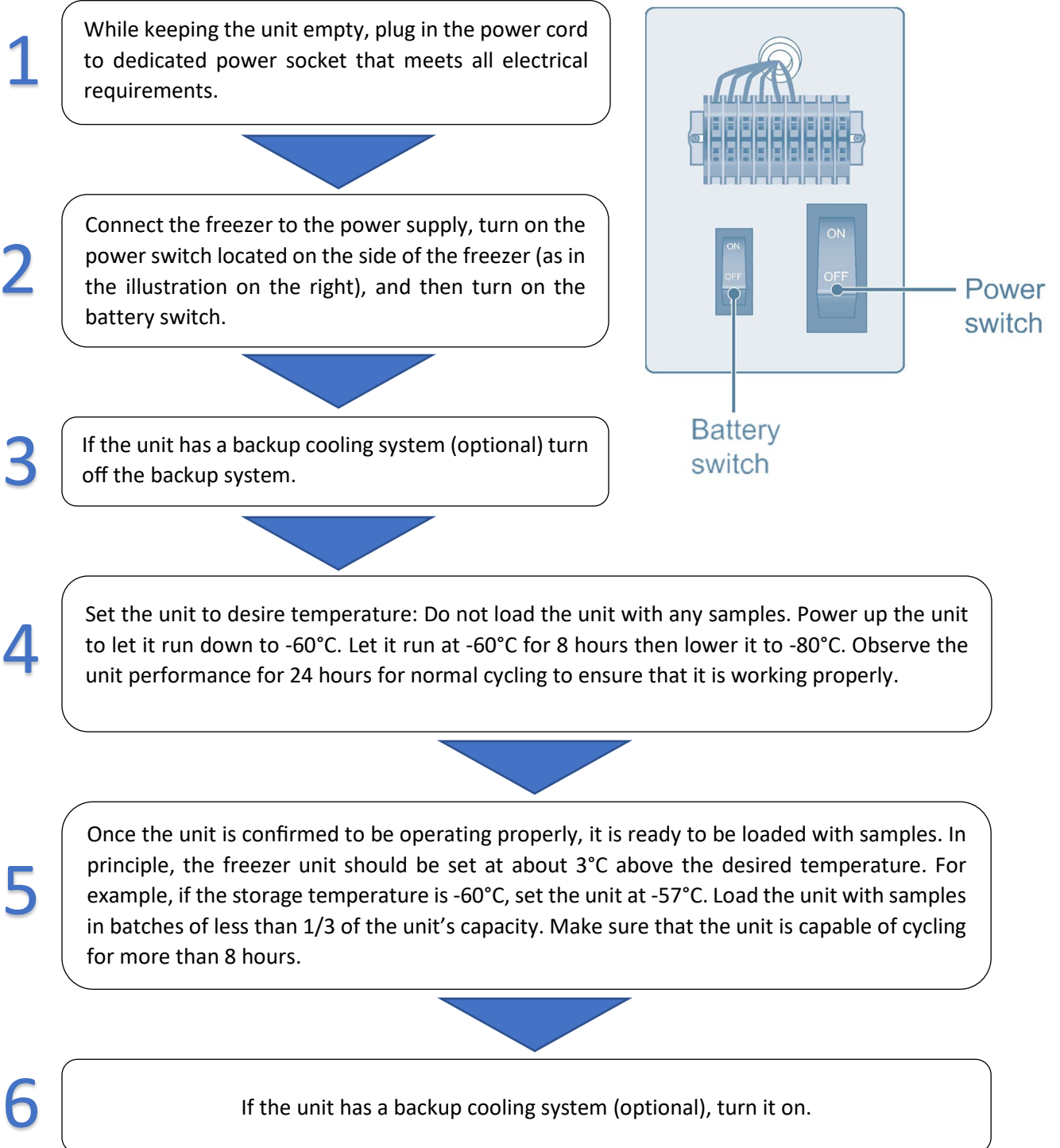

- If the freezer temperature warms up, and the issue can't be resolved within a short time, please transfer the stored products to another freezer to avoid potential damage.
- Before placing samples in the freezer for storage, check the freezer temperature to make sure the temperature meets the storage requirement for the samples. This is to prevent any potential damage to the samples due to incorrect storage temperature.
- Since it takes time to remove lower the temperature of the stored product, there can be a difference between the set temperature and the displayed temperature. This difference will get smaller as the set point is lowered.

Samples must be loaded in batches, while gradually decreasing temperature setting. The process should be repeated until the final temperature is reached.

- Do not use any unauthorized mechanical tools or other means to accelerate the defrosting process.
- Do not damage the refrigeration circuit.
- Do not use any unapproved electrical components in the freezer.

It is not recommended to load excessive amounts of samples into the unit at one time. Overloading may result in inadequate performance. The freezer and the compressors can become overheated and malfunction.

5.5 Operation after a Power Outage

Your ULT freezer control settings are stored in its memory system. Should there be power outage and recovery, the unit can resume its operation based on the previous settings.

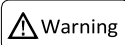

- In the event of a power outage and recovery, be sure to wait for at least 5 minutes before turning the unit on again to avoid damaging the compressors and refrigeration system.
- If the unit is not in use for a long period of time, make sure the power cord is unplugged. Deteriorated insulation of the power cord may lead to electric shock or fire.

6.0 Freezer Components

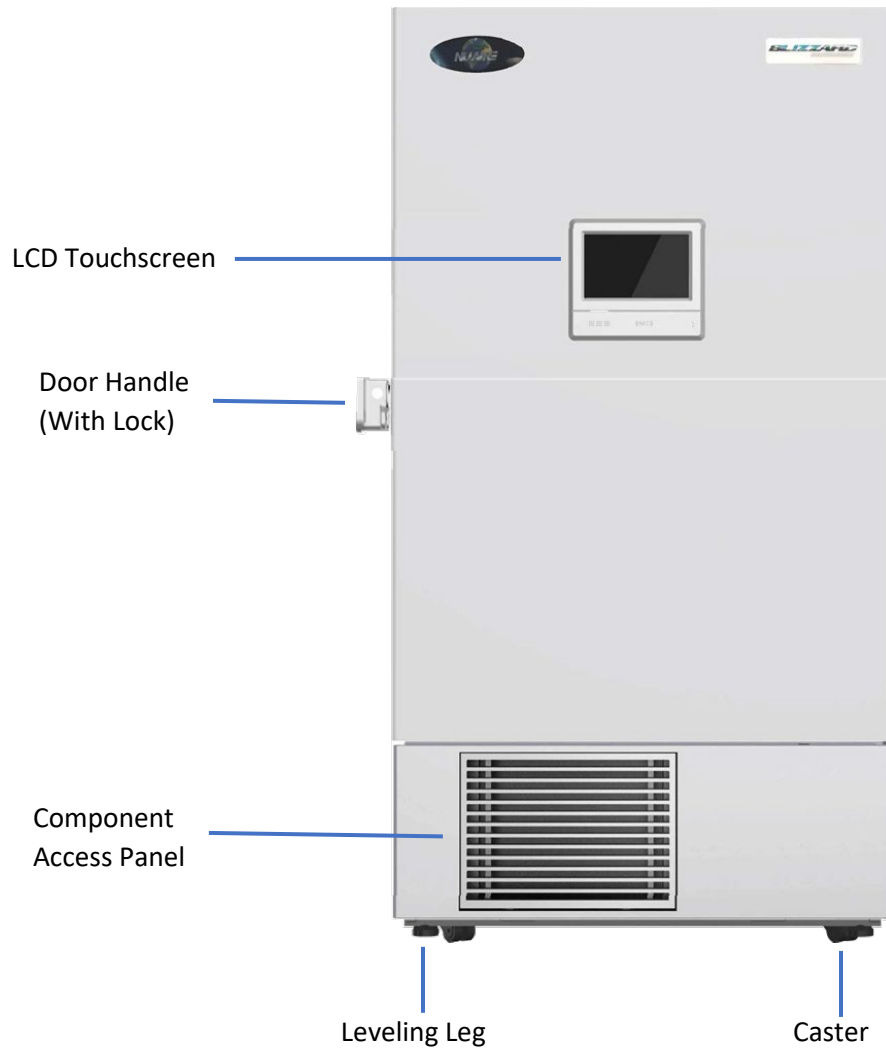

6.1 Control Panel



7.0 Operation

7.1 Homepage



The Homepage can display the real-time internal temperature, ambient temperature, set point, input voltage, network state, user login status, freezer health status, temperature graph, and message/ note book, backup system state (optional), electromagnetic lock state (optional), etc.

Icon of real-time internal temperature:

The icon reflects the health status of the freezer by changing colors:

Green: System is operating normally.

Yellow: System occurs a general alarm that does not affect the internal temperature. Example, ambient temperature alarm.

Red: System has a serious alarm affecting the internal temperature. Example, power failure alarm.

Homepage Symbols:



Tap to enter the sample management interface



Tap to enter the graph viewing interface, where temperature records can be downloaded



Tap to enter the information search interface



Tap to enter the freezer setting interface



Indicates that the network is enabled



Indicates that the electromagnetic lock has been installed and is in the locked state. (Optional)



Tap to enter the configuring the sample bank server address and port interface.



Tap this button to enter the Alarm Record interface where the alarm record can be downloaded. When occurring a serious alarm that affects the temperature inside the freezer, this icon turns **Red**, and when occurring a general alarm not affecting the internal temperature, the icon turns **Yellow**. The buzzer can be cancelled after tapping.



Click to enter the message and notebook interface.

Backup system  Indicates that the Backup System status:

● Green: Backup System is running.

● Grey: Backup System is off.

7.2 Settings



- **[Temperature]**

Set the internal temperature and high- / low- temperature alarm value. Select the internal temperature value or high- / low- temperature alarm value to be set, and then use the button of “+” / “-” for adjustment (You can also pop up a value selection box by clicking the value and selecting the value by scrolling the selection box up and down). Click Save to finish settings.



[Set Point]:

Use to set the required temperature inside the freezer, with the adjustable range of -10°C ~ -86°C.

[Low temperature alarm]:

Use to set the alarm value of low temperature alarm inside the freezer, with the adjustable range of -15°C~-99°C, which needs to be lower than or equal to the internal temperature value minus 5°C. When the set value of internal temperature is changed, if the low temperature alarm value is not lower than or equal to the temperature value inside the freezer for more than 5°C, the low temperature alarm value will be automatically adjusted to the set value of internal temperature - 5°C.

If the low temperature alarm value is lower than or equal to the temperature value inside the freezer for more than 5°C, the low temperature alarm value will not change.

[High temperature alarm]:

Use to set the alarm value of high temperature alarm inside the freezer, with the adjustable range of 0°C ~-81°C, which needs to be more than or equal to the internal temperature value plus 5°C. When the set value of internal temperature is changed, if the high temperature alarm value is not more than or equal to the temperature value inside the freezer for more than 5°C, the high temperature alarm value will be automatically adjusted to "the set value of internal temperature +5°C.

If the low temperature alarm value is lower than or equal to the temperature value inside the freezer for more than 5°C, the low temperature alarm value will not change.

- **[Initial]**

Tap to set the language, date, time. Click any one value to pop up a selection box, and then you can select more values by sliding the values in the selection box up and down. When the setting is complete, click "Save", and then you can see that the time in the upper middle of the screen will be synchronized to the set value



[Language Selection]:

Select the language.

[Timezone Adjustment]:

Select the current location's timezone.

[Time Adjustment]:

Set the time value to the local actual time. The default value is read from the main control board. If there is no communication with the main control board, the last displayed time shall be the default value. NOTE: If the time value does not match the local time, it will affect the time display of the curve.

[Temperature Scale]:

Set the temperature standard, Celsius (°C) or Fahrenheit (°F).

- **[Operation]**

Tap to set the alarm volume, screen brightness, screen auto-lock, auto-logout time, operational mode, account login mode, time delay to alarm, default display range of graph, time delay to start, ambient temperature alarm, time to door opening alarm, update and reboot.

[Alarm Volume]:

Adjust the slider to decrease (to the left) or increase (to the right) the volume of the alarm.

Tap  to "Mute".

[Screen Brightness]:

Adjust the slider to decrease (to the left) or increase (to the right) the brightness of the LCD screen.

[Screen Auto-Lock]:

Tap to set how long before the screen will enter the sleep state for protection after having not clicked it to extend the service life of the screen, with the default value of 5min. Selectable options include: 5min, 10min, 15min, 20min, and Never. if you choose "Never" the screen will enter the screen saver 5 minutes later. After the screen sleep, click anywhere on the LCD screen, it will automatically wake up and enter the homepage.

Choose "never" after no operation within 5 mins the display will enter screensaver mode.

[Auto-Logout Time]:

Tap to set how long the logged-in account will automatically log out after having not carried out any operation to protect the account security, with the default values of 5min. Selectable options include: 5min, 10min, 15 min and 20min.

[Operational Mode]:

High performance: Provides high temperature uniformity and stability of the temperature inside the freezer to store the sample with a very strict temperature control requirements of the internal temperature.

Energy saving: Compared with high-performance mode, it can save up to 10% of electricity. This mode has less strict temperature control requirements of the internal temperature.

- **[Backup]**

Tap to turn the backup system ON/OFF, type of backup system, and injection temperature, and projected injection time. It can set when connecting with backup system but cannot set when there is no backup system, and the display will show in gray.



[Backup System]:

Tap to turn the backup system ON/OFF (optional), click "On"; and then click "Off" after the completion of use.

[Backup System Type]:

Liquid Nitrogen (LN2) or Liquid Carbon Dioxide (LCO2)

[Set Injection Temperature]:

Set the temperature when the backup system starting spraying:

Liquid nitrogen (LN2), the default temperature is -70°C, with the adjustable range of 0 ~-100 °C.

Carbon dioxide (LCO2), the default temperature is -70 °C, with the adjustable range of 0 ~-70°C.

NOTE: The set spraying temperature cannot to be lower than the high-temperature alarm value. If the set spraying temperature is lower than the high-temperature alarm value, it cannot be saved.

[Project Injection Time]:

When installing a backup system, the user can fill enter the estimated usable time of the backup system. When needed to confirm the remaining conditions after the backup system has been used, the user can query its cumulative spraying time, and then judge the usage conditions of the backup system through the difference between these two.

[Injection Test]:

When the temperature inside the freezer does not reach the set spraying temperature, you can tap [Injection test] to simulate the spraying conditions to confirm whether the spraying system can be normally used. If the displayed temperature inside the freezer is greater than the set temperature, after pressing the button of "Injection test", the displayed temperature is unchanged, and the indicator light of backup system on the homepage is ON; at this time, control to open the solenoid valve for spraying, and stop the spraying 10 seconds later. If he displayed temperature inside the freezer is less than the set temperature, after pressing the button of "Injection test", the displayed temperature changes rapidly to the set temperature; at this point, control to open the solenoid valve for spraying, and stop the spraying 10 seconds later; after that, the displayed temperature will return back to the actual temperature inside the freezer.

- **[Network]**

Tap to set the network ON/OFF : After the network search is completed, click the corresponding network, and enter a password for login, then connect to the network successfully. A Wi-Fi connections is recommended so that the touch screen can be remotely updated.



[Network Name]: Connected Wi-Fi name

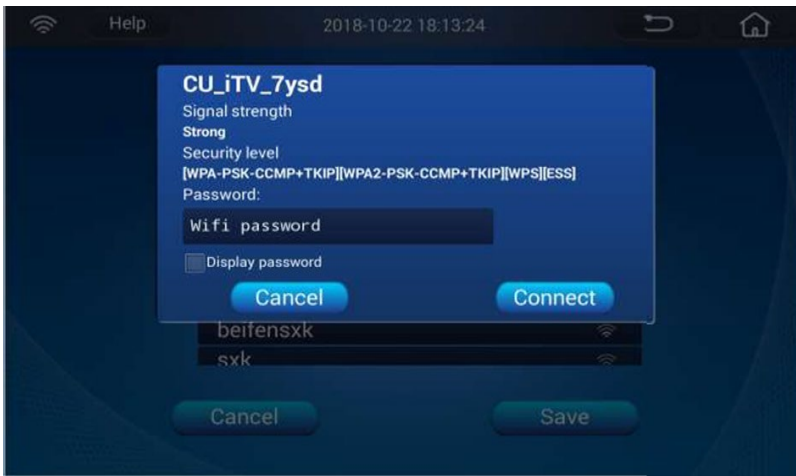

- **[User]**

Tap to add, edit, delete user accounts, and set user account permissions.

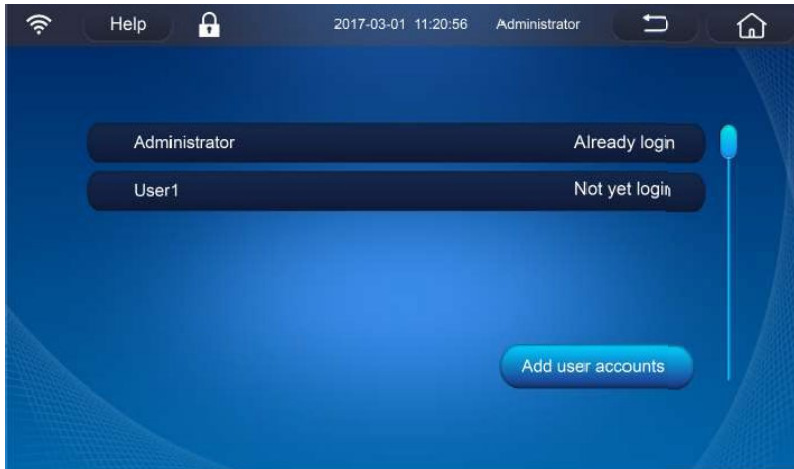

[Add User Accounts]:



[Account]: Create an account name.

[Password]: Create a password for the account.

[Confirm Password]: Enter password again to confirm.

[Account Type]:

User: Normal users can only view, query and save the freezer's information, as well as use message and notebook functions, but cannot change the freezer settings.

Administrator: Administrators have all the functions of a normal user and can change the settings.

[Contact]: Enter contact information (not required).

[Register Fingerprint] (Optional):

When using a fingerprint lock, click [Register fingerprint] to pop up the prompt fingerprint registration, and then complete the registration of fingerprint on the freezer. After that, the user can open the door by using the fingerprint or log in the account in the authorization mode. When unlocking the lock, press the fingerprint directly; when logging in an account, select [Register fingerprint] on the login screen.

When the electromagnetic lock is not used, the registered fingerprint can be used for account login on the login interface under the authorization mode.



[Register Card] (Optional):

When using a card-punching lock, click [Register Card] to prompt the card registration, and then complete the registration of IC card on the freezer. After that, the user can open the door by punching the card or log in the account in the authorization mode. When unlocking the lock, punch the card directly in the unlocking zone; when logging in an account, select [Register Card] on the login screen.

When the electromagnetic lock is not used, the registered card can be used for account login on the login interface.

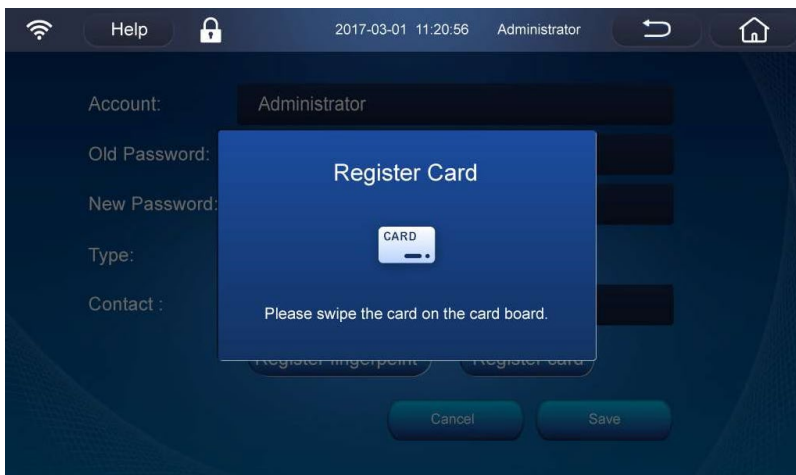

[Delete]:

Select an existing account, and then tap it for login to delete the existing account.

7.3 Graph

View the graph of temperature inside the freezer, and it can be used to select the graph within the selected time period and then download the temperature record. In addition, the graph that exceeds the alarm value of high- and low- temperature will be shown in red.



[2h]: View the temperature graph of the last 2 hours (Default. The default display range of graph can be modified in the operation settings).

[24h]: View the temperature graph of the last 24 hours.

[7day]: View the temperature graph of the last 7 days.

[One month]: View the temperature graph of the last 1 month

Graph Elements: The middle line is the line of the set temperature inside the freezer
 the upper & lower lines are high-/low- temperature alarm value, respectively.

NOTE: The graph can be scaled by sliding the screen.

Tap anywhere on the graph to view the temperature value at a fixed point.

[Inquiry]: Input both the starting time and the ending time, and then tap [Inquiry] to view the temperature graph in the desired interval.

NOTE: If the interval is more than one month, the graph cannot be viewed.

[Download]: Input both the starting time and the ending time, and then [Download] to download the temperature data within this interval through USB.

NOTE: If no interval is entered, all temperature data will be downloaded by default.

Data can be exported in CSV or PDF.

NOTE: When you choose PDF format at the interval between the start time and end time cannot exceed 7 days.

7.4 Inquiry

This page has six query buttons: Event Record, Power and Battery, Alarm Record, Operating Status, Backup System and Device Information.



- **[Event Record]:**

Tap to query the records of Door Opening/Closing, Setting & Modification, Data Upload/Download and Account Login/Logout.

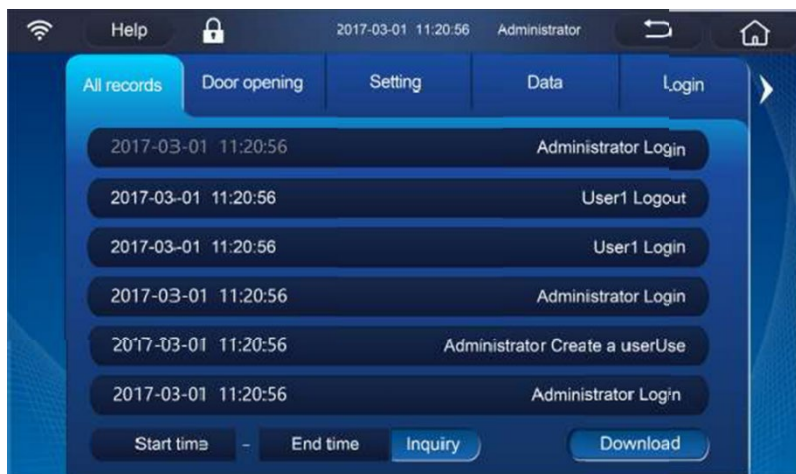

[Inquiry]: Input both the starting time and the ending time, and then tap [Inquiry] to view the corresponding records in the desired interval.

[Download]: Input both the starting time and the ending time, and then [Download] to download the corresponding records within this interval through USB.

- **[Power and Battery]:**

Tap to view both the main battery and the backup system battery's input voltage, output voltage and remaining battery level



- **[Alarm Record]:**

Tap to query the All alarms, or check individual alarms: Logins, Door Alarm, Power Alarm, Battery Alarm, Sensor Alarm, Temperature Alarm, Condenser Alarm, and Backup Alarm.

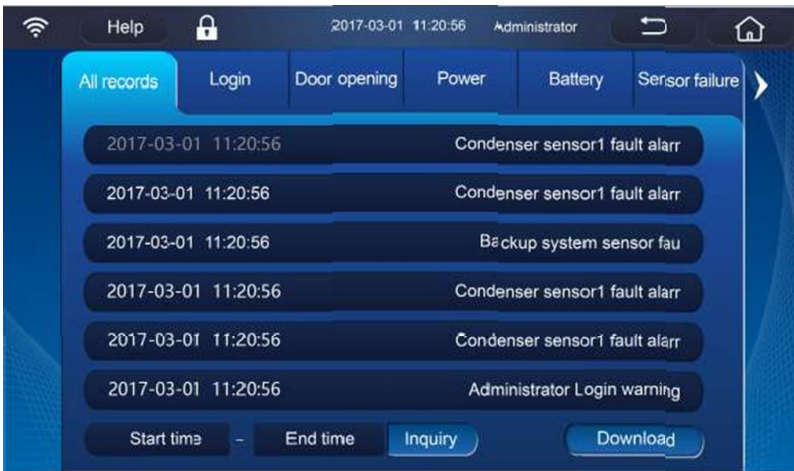

[Inquiry]: Input both the starting time and the ending time, and then tap [Inquiry] to view the corresponding records in the desired interval.

[Download]: Input both the starting time and the ending time, and then [Download] to download the corresponding records within this interval through USB.

- **[Operating Status]:**

Tap to query the freezer's real-time Internal Temperature, Set Temperature, High-/ Low- Temperature Alarm Value, Ambient Temperature, Input Voltage, Cumulative Operation Time. The status of the Compressor, Fan; as well as the data recorded by the electronic temperature recorder.

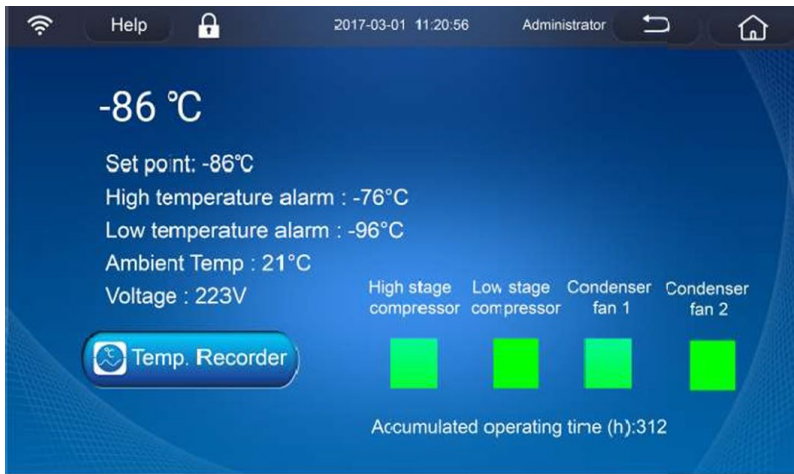

For the operation state of compressors and condenser fans; “Green” indicates that it is running and “Grey” indicates that it is not running.

[Temp. Recorder]:

The electronic temperature recorder is used to collect the temperature inside the freezer. Tap [Temp. Recorder] to view the recorded internal temperature. Tap [Download] to download the temperature data via USB.



- **[Backup System]:**

Tap to view the Operating Status, Injection Status, Accumulated Injection Time, and Injection History. It can set when connecting with backup system. If no backup system is present, the display will show in gray.



[Injection History]:

Displays the accumulated injection time since the last start-up.

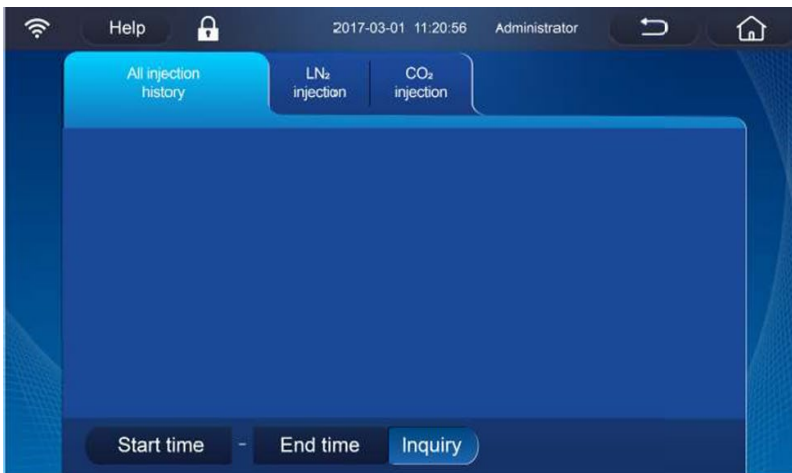

[Inquiry]: Input both the starting time and the ending time, and then tap [Inquiry] to view the corresponding records in the desired interval.

[Reset Injection Time]:

Clear some or all injection history.

- **[Device Information]:**

Tap to query and save the related information, electronic manual of the freezer, as well as upload/download its configuration file and database information.

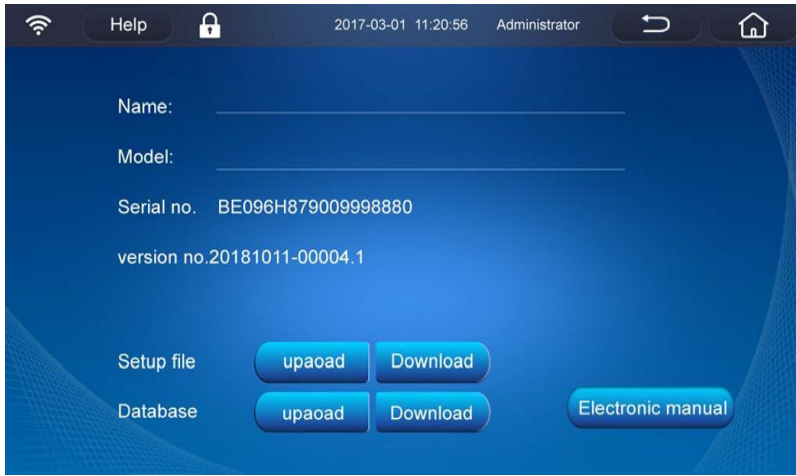

[Setup File]:

Tap [Download] to download the set parameters of this freezer to a USB disk in the established format via USB, and then plug the USB disk that has saved the downloaded file to the USB interface of other freezers.

Tap [Upload] to upload a configuration file.

[Database]:

Tap [Download] to download the temperature data, alarm records, event records of this freezer to a USB disk in the established format via USB, and then plug the USB disk that has saved the downloaded file to the USB interface of other freezers.

Tap [Upload]” to upload this database to other freezers if desired.

[Electronic Manual]:

View the manual on the display screen.

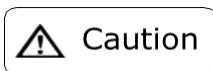

- When exporting data to a USB, ensure USB disk is type FAT32.
- If the FAT32 USB disk cannot export data, please backup the file of the USB disk first and then format the USB disk or try another brand FAT32 USB disk.

7.5 Message

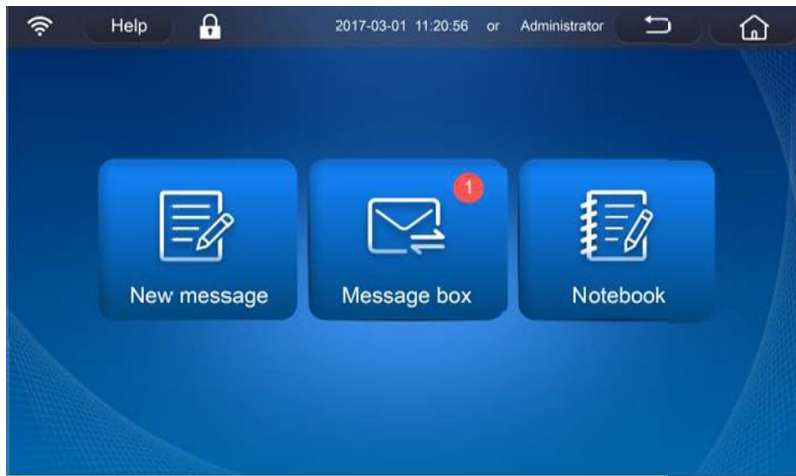

[New Message]:

Create a message by tapping [New message]. Select the users the message will be sent to, enter a title in the title bar, and enter the message content in the text box, then tap [Send].



[Message Box]:

Tap [Inbox] to view the messages that have been received. When a message has been read, the font will become gray.

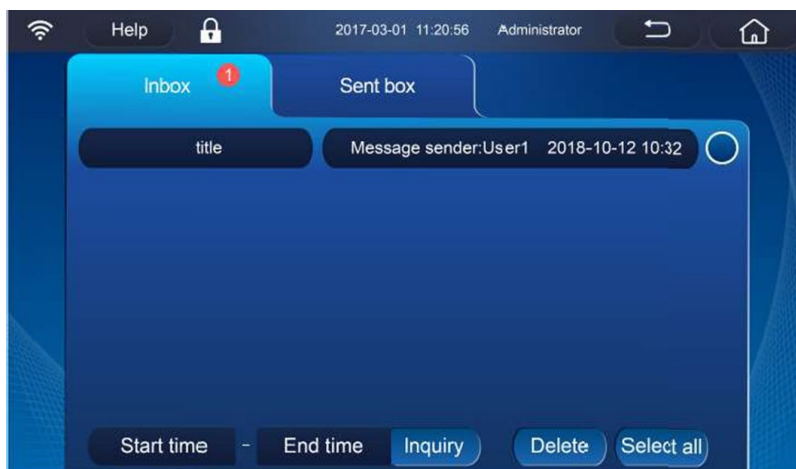

Tap [Sent Box] to view messages that have been sent.

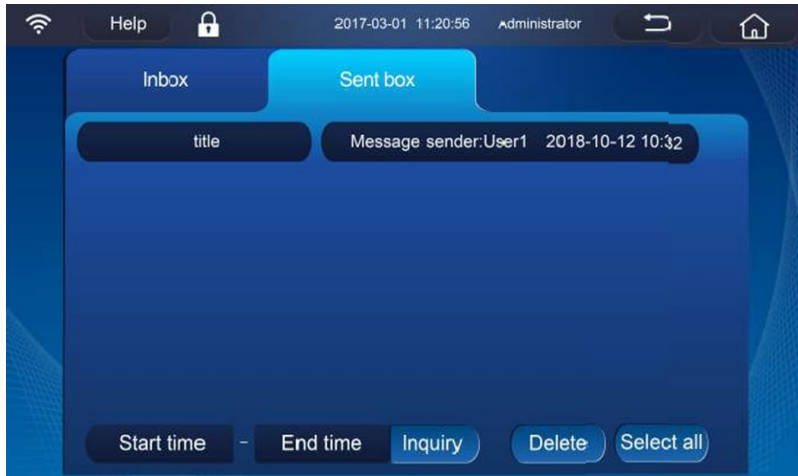

[Notebook]:

Create new messages and view the records. For previous records, you can directly click them for modification and saving in the pop-up interface; when clicking [Delete], you can delete one or all messages.

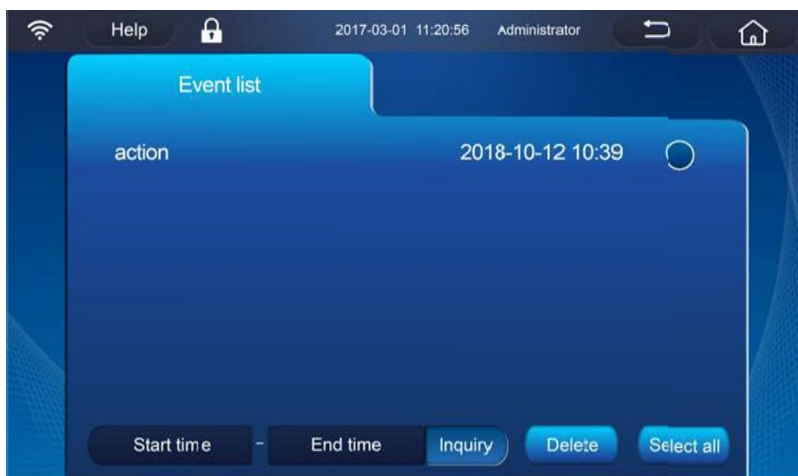

7.6 Alarm

Alarm Type	Tricolor lamp panel	Buzzer	Prompt box pops up?
High-low temperature alarm	Red	Y	Y
Power-off alarm	Red	Y	Y
Door opening alarm	Red	Y	Y
Main temperature sensor fault alarm	Yellow	Y	N
Heat exchanger fault alarm	Yellow	Y	N
Condenser dirty alarm	Yellow	Y	N
High ambient temperature alarm	Yellow	Y	N
Battery fault alarm	Yellow	Y	N
Backup system fault alarm	Yellow	Y	N

- Automatic Recovery of Alarm
 - Tap [x] on the upper right-hand corner in the prompt box to stop the buzzer alarm. If there is no prompt box, click the alarm on the bottom of the homepage to view the alarm, and then stop the buzzer alarm.
 - If the alarm condition is still active, the buzzer alarm will be recovered automatically 30 minutes after ceasing.
- Remote Alarm Terminal
 - The remote alarm terminal is installed on the right side of the freezer's engine cabin, and the alarm signal will be output by this terminal. The load capacity of the terminal is DC 30V, 2A.
 - Contact output:

The remote alarm terminal is divided into: Normally open, normally closed, common terminal. Users may select normal open or normal close according to their own requirements.
 - Standard R485 port can be used to transmit freezer temperature data to customer's software for monitoring

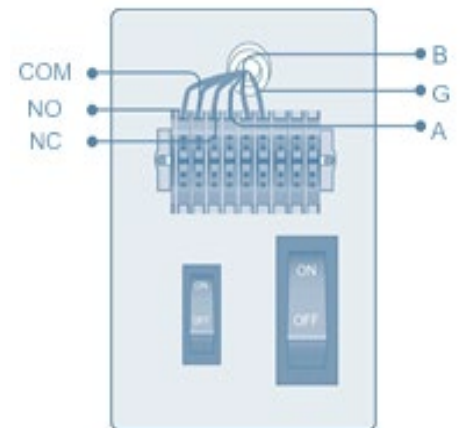

8.0 Cleaning Maintenance



- To prevent electric shock or injury to operators, the AC power supply to the freezer must be disconnected completely before any repair and maintenance work is to be performed.
- During any repair maintenance work, do not inhale medical particles or aerosols near the equipment as they might be harmful to your health.

8.1 Cleaning the Freezer

- Clean the unit at least once a month.
- Use a dry cloth to wipe away loose dust inside and outside of the freezer. If the unit is dirty, use a clean cloth soaked with a neutral detergent to clean the unit. Then use a dry cloth to wipe away any residual detergent solution.
- Never pour water onto or into the unit. Doing so can damage the electric insulation and cause failure.
- Compressors and other mechanical parts are hermetically sealed, and they do not need lubrication. Users should remove the frost on the chamber and clean the condenser filter as often as possible.

8.2 Cleaning the Condenser Filter

Clean the condenser filter when the control panel shows a signal for "Hot Condenser" and the alarm flashes. Even if the light is not on, the condenser filter should be checked regularly according to the suggestion from the distributor.

To clean the filter, follow the procedure below.

1. Pull off the front grill cover.
2. Pull out the filter screen.
3. Use water to wash the filter screen.
4. After the filter screen is dry, reinstall it back in its original position and close the cover.
5. If the "Hot Condenser" light is on before cleaning, check the light to make sure that it shuts off after cleaning. If it does not shut off, please contact after-sales service personnel.

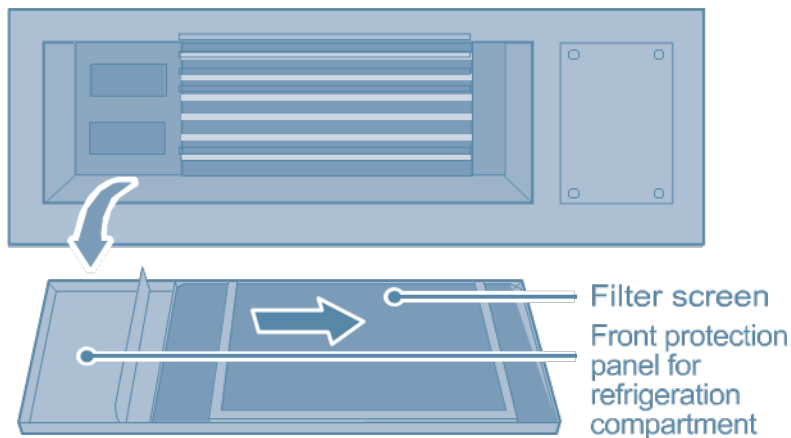

8.3 Defrosting

Frost and ice can form in between the door gasket and frame to form an air gap, which can decrease the refrigeration effect of the unit. Please use the provided plastic scraper to defrost the interior doors.

1. To defrost, please refer to the instruction as follows:
2. Turn off any backup refrigeration system if there is one.
3. Remove the samples from the unit that needs to be defrosted. Move them to another unit or a container for temporary storage.
4. Turn off the power supply.
5. Open the outer door and inner doors to let the unit thaw.
6. Use a dry doth to soak up and remove any water on the floor of the unit. Load the samples back into the unit after it reaches the set temperature.
7. Turn on the backup refrigeration system if there is one.



Caution

Do not use any sharp tools such as knives or screwdrivers to defrost.

8.4 Battery Maintenance

- When the control panel shows an alarm signal for “Low Battery”, check that the battery switch is turned on, and the battery is charged. After one week of charging, recheck the battery capacity. If normal, the battery should be in full capacity. If the capacity is still low, continue charging the battery. If the battery is not charging, contact Nuair.
- The battery that supports the power outage alarm is a consumable item. The life expectancy for the lithium battery is 5 years (Lead-acid battery is 2-3 years). If the battery is more than 5 years old (Lead-acid battery 2-3 years), the battery should be replaced because the alarm function may not work properly. Contact Nuair for assistance.

8.5 Disposal of Freezer

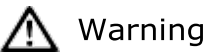

Warning

- If the unit is to be stored unused in an unsupervised area for an extended period, ensure that the doors are locked completely with a key.
- The disposal of the unit should be accomplished by appropriate personnel. Remove doors to prevent accidental injury.

8.6 Disposal of Battery

This freezer is equipped with a rechargeable battery. This battery is recyclable. When the battery reaches the end of its life, please contact a local recycling organization for inspection or properly discard the battery.

1. Location of the battery.

The battery in the electric cabinet is for the power outage alarm. It is located inside the control box of the right side of the unit.

 To prevent electrical shock, only a qualified technician should replace the battery.

2. Removal of the battery

- Turn off the power of the unit and unplug the power cord from the socket.
 - Use a screwdriver to remove the screws on the side panel and take down the side panel.
 - Unplug the connecting terminals from the battery.
 - Remove the bracket that holds the battery in place. Remove the battery.
 - Follow regulations to recycle the battery or discard it properly.
-  When changing the battery, you must make sure that the brown wire connects to the positive pole of the battery, and the blue wire connects to the negative pole of the battery. The polarity must not be reversed. Incorrect polarity can damage the main control board and it will not charge the battery.

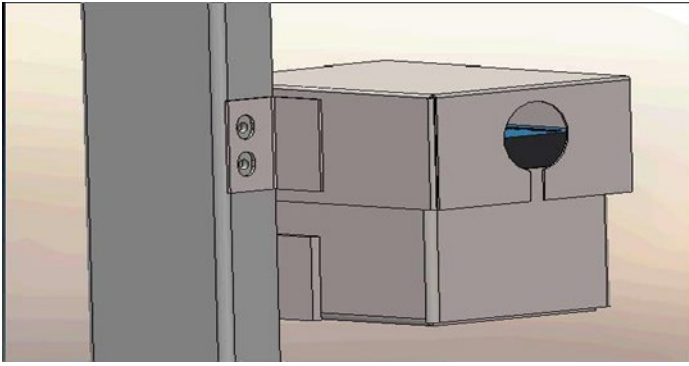

 Caution

After interruption of power supply, the battery can maintain the standby time of the touch screen for ~22 hours.

9.0 Optional Accessories

9.1 Temperature Recorder

When using the temperature recorder, please refer to the “User manual for Temperature Recorder” provided with the recorder.

 Caution

The temperature recorder should only be installed by professionals or Nuair approved Service Provider.

 Warning

Before installing the temperature recorder, please cut off the power supply to avoid electric shock or fire.

9.2 LCO₂ Backup Cooling System

For installation and operation of the backup cooling system, please refer to the user's manual provided with the system.

 Caution

For LCO₂ back up system, please make sure the LCO₂ supply bottle has an internal liquid dip tube to make sure the liquid is fed to the backup system. For LN₂ backup system, please use a LN₂ Dewar of 35 to 50 psig.

 Warning

- Whenever a CO₂ or LN₂ backup system is installed, the location of the freezer must be well ventilated. Increased concentration of CO₂ in the air is harmful and even fatal. If the ventilation is poor, alternative methods should be considered to reduce the nitrogen or CO₂ concentration to the normal level.
- If a LCO₂ or a LN₂ cylinder fell to the ground, its valves may get damaged, resulting in a risky condition. Fastening the bottles with a chain are to secure them to ensure the bottles are positioned vertically and securely.

- The temperature of liquid CO₂ /LN₂ is extremely low, which could cause frostbite. When replacing the cylinder, please always wear a pair of protective glasses and protective clothes.
- This kind of backup cooling system should be used with the LCD panel.

9.4 Electromagnetic Lock

The electromagnetic lock can effectively enhance the safety of specimen access inside the freezer, which is convenient for use. When using it, make sure to swipe the card or use the fingerprint to unlock the lock before opening the door. If not swipe the card or use the fingerprint, or pull the handle forcibly, it may destroy the electromagnetic lock.

Usage method:

- Before using the electromagnetic lock for the first time after unpacking, firstly open the door, and then remove the small clip for fixing the spring of electromagnetic lock.
- When the electromagnetic lock is unlocked, it may continuously maintain the open state for about 10 seconds. If more than 10 seconds later, you need to open the door once again, please swipe the card or punch the fingerprint. The unlocked/ locked state of electromagnetic lock is displayed on the touch screen.
- If the freezer operates in normal mode, any attached magnetic card can be used to open the door by swiping it in the card reading area of the display panel cover, but the fingerprint does not have the function.
- If the freezer operates in authorized mode, first ensure that the magnetic card or fingerprint is registered on it. When you can create a new account, the registration will be completed by swiping the card or punching the fingerprint, meanwhile a magnetic card shall be assigned to the new account. Only when the magnetic card corresponds to the login account, can the electromagnetic lock be unlocked.



- If the user does not use the electromagnetic lock temporarily, it can be fixed with a clip, to ensure that the door can be opened / closed without swiping the card or using the fingerprint.
- When there is a loss of power or the backup battery power is out of power, please contact technical support personnel should there be a need to open the freezer door.
- If the card is not swiped or fingerprint information is not entered, the door should not be opened forcibly as it can damage the electromagnetic lock.

9.5 Frozen Storage Racks and Storage Boxes

When the freezer stores small sizes of materials, the frozen storage rack and the frozen storage box can be used to utilize the space more effectively.

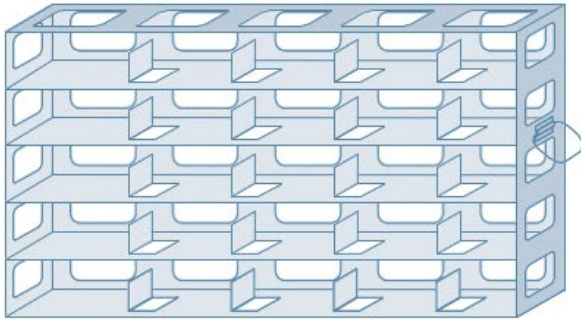

Type A frozen storage rack (side fetching type)

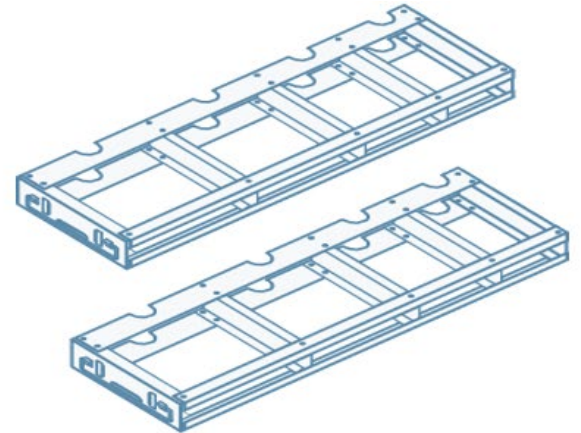

Type B frozen storage rack (drawer type)

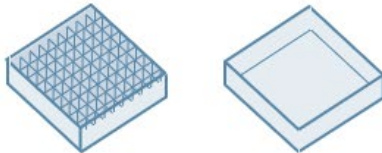

Frozen storage box

Model	Storage Rack (Type A/B are available)		Storage Box
	Variety	Amount	Amount
NU-99729VFT	5×5	20	500

10.0 Troubleshooting



Should there be any malfunctions in the system, please attempt to answer the following questions before notifying maintenance or calling Nuair. Please do not dismantle the freezer yourself.

Fault	Troubleshooting
Freezer does not start up	Is the power supply normal? Has the main protector been turned on yet?
	Is the voltage supply too low?
	Is there any voltage input from the outside?
Poor refrigeration effect	Is the ambient temperature too high?
	Are the inner doors and outer doors closed properly? (Has any ice or frost damaged the seals between the door and the frame?)
	Is the condenser filter clogged?
	Is the temperature setting correct?
	Is the freezer being kept away from direct exposure to sunlight?
	Is the freezer near any heat source?
	Is the porthole plug installed in the porthole with proper insulation materials?
	Has the freezer been loaded with too many non-frozen samples within the last few hours?
The unit is noisy	Is the unit set on a firm and level floor?
	Is the exterior of the unit touching any objects?
	Is the freezer unit leveled with the leveling legs?

11.0 Refrigeration and Wiring Diagram

11.1 Refrigeration Diagram

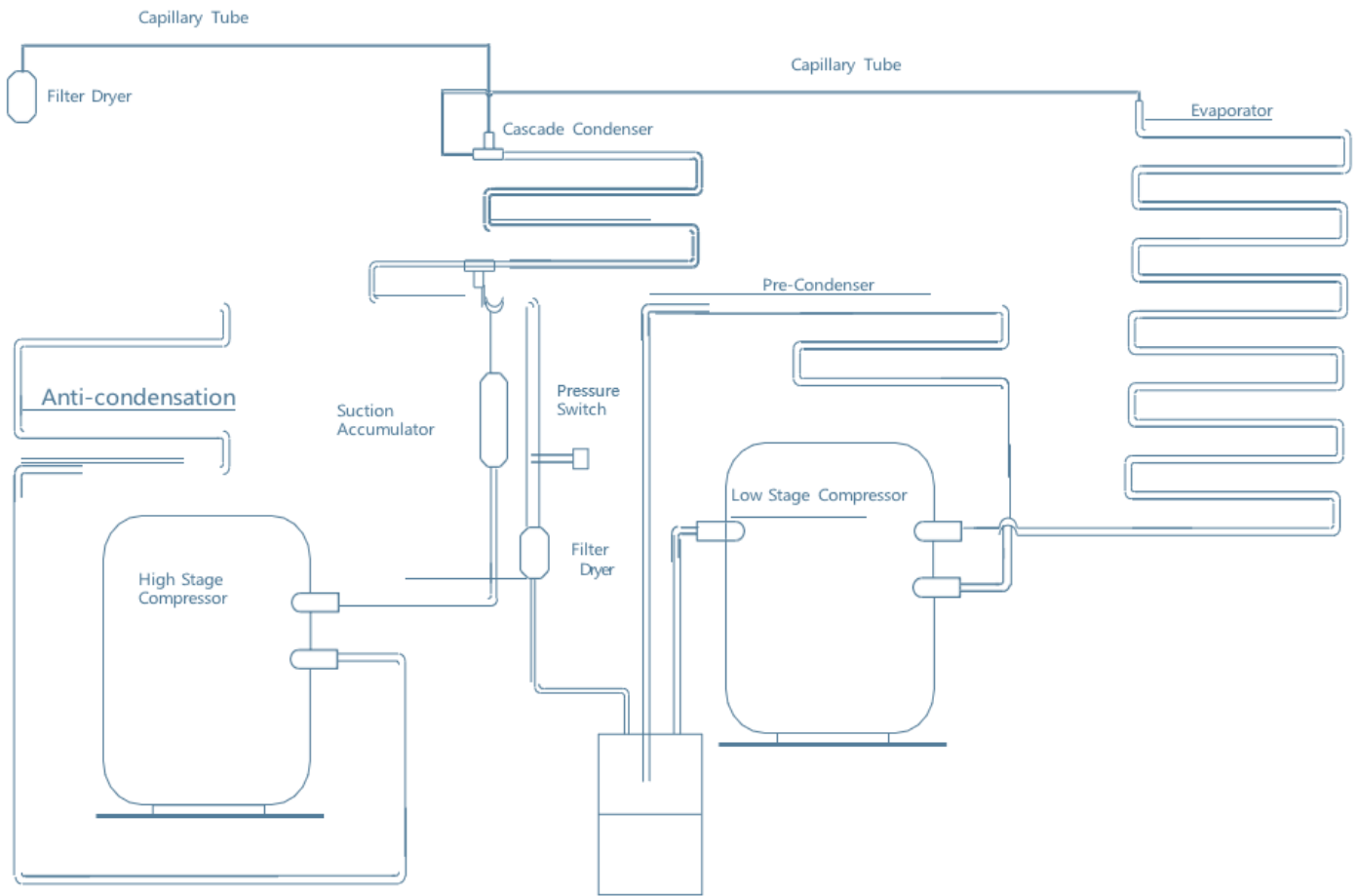

11.2 Wiring Diagram

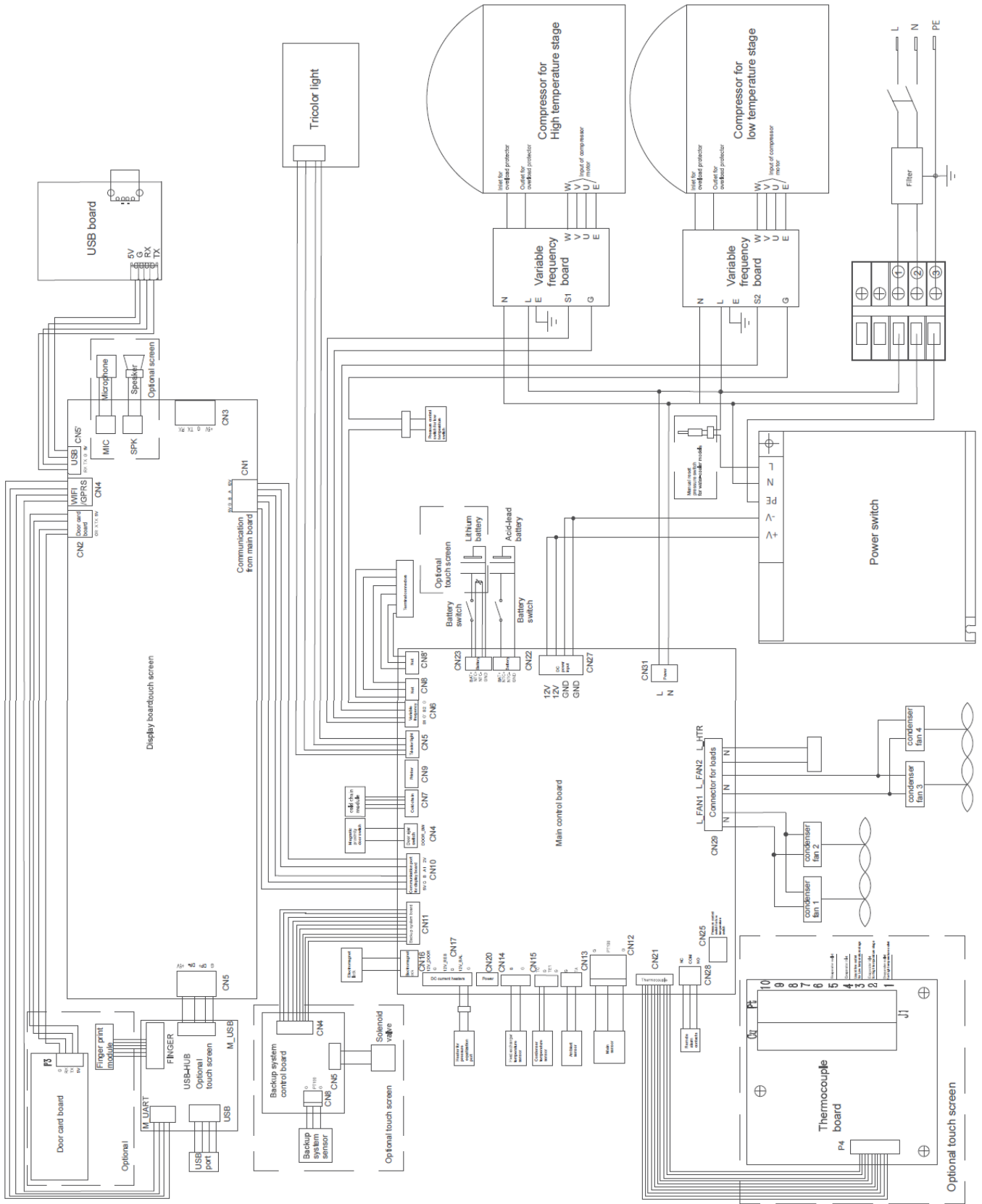

12.0 Specifications and Technical Data

12.1 Specification Table

Name	Ultra-Low Temperature Freezer
Model	NU-99729VFT
Exterior/Interior Wall Material	Coated cold rolled steel
Outer Doors	Coated cold rolled steel
Inner Doors	Plastic framed PS board
Shelves	Stainless shelves (height adjustable)
Porthole for Testing	2
Insulation	Vacuum insulated with polyurethane foam (non-CFC)
Compressors	High stage: hermetically sealed Low stage: hermetically sealed
Evaporator	Copper tube
Condenser	Finned coil
Refrigerant	R170 R290
Temperature Controller	Microprocessor controller
Temperature Display	LCD display
Temperature Sensor	RTD (Pt100)
Alarm Device	High/Low temperature alarm, probe failure alarm, Hot condenser alarm, Ambient temperature alarm, Low battery alarm, Door ajar alarm, Power failure alarm
Battery of Remote Alarm Terminals	Maximum load:3 0VDC, 2A Rechargeable battery: 12 VDC, charges automatically Lithium battery
Electric Shock Protection Type	I
Ambient Temperature	10 to 32 °C
Freezer Temperature	-40 to -86 °C
Foaming Cabinet	HFO-1233zde
USB	Standard
Rs485	Standard
Pollution Degree	2
Overvoltage Category	II

12.2 Technical Data

Model	Net Volume (L)	Rated Voltage (VAC)	Rated Frequency (Hz)	Rated Current (Stable Current) (A)	Rated Power (W)	Weight (kg)	Dimensions (WxDxH) Inches [mm]
NU-99729VFT	729	100-230~	50/60	7.0 (3.0)	460	350	41.2" x 38.9" x 78.0" [1046 x 998 x 1980]

12.3 Global Warming Potential

Model	Rated voltage (VAC)	Rated frequency (Hz)	CO2 equivalent (Tonnes)
NU-99729VFT	100-230~	50/60	0.005

This product contains fluorinated greenhouse gases covered by the Kyoto Protocol. Do not vent into the atmosphere.

GWP=global warming potential

Refrigerant type	GWP
R170	20
R290	20