

LabGard® Containment Ventilated Enclosure

Model

NU-813-300/400/600

NU-813-300E/400E/600E

Portable Bench Top

Operation & Maintenance Manual

February, 2019

Series 33

Revision 9

Manufactured By:

NuAire, Inc.

2100 Fernbrook Lane

Plymouth, MN 55447

Toll-Free: 1-800-328-3352

In Minnesota: (763)-553-1270

Fax: (763)-553-0459

ABOUT THIS OPERATION & MAINTENANCE MANUAL

The information contained in this manual is intended to reflect our current production standard configuration model along with the more frequently purchased options. Any unique additions/modifications/shop drawings are appended in the back flap of this manual, along with any modifications and/or additions to procedures as outlined in this manual. A copy of the original factory test report is also appended to this manual. In case this manual and/or test report is lost or misplaced, NuAire retains a copy in our files. A replacement copy can be obtained by calling or writing NuAire, Inc. stating the model number and serial number and a brief description of the information desired.

LabGard® Containment Ventilated Enclosure
Models NU-813-300/400/600
NU-813-300E/400E/600E

Operation & Maintenance Manual

TABLE OF CONTENTS

Section No. 1.....	General Information
Section No. 2.....	Models & Features
Section No. 3.....	Warranty
Section No. 4.....	Shipments
Section No. 5.....	Installation Instructions
5.1	Location
5.2	Electrical Services
5.3	Final Assembly
5.4	Certification Testing Methods and Equipment
Section No. 6.....	Operating the NU-813
6.1	Operator Controls & Indicators
6.2	Operating Guidelines
6.3	Ergonomics
6.4	Cleaning Procedures
Section No. 7.....	General Maintenance
7.1	Decontamination
7.2	Fluorescent Lamp Bulb Replacement
7.3	HEPA Filter Replacement
7.4	Motor/Blower Replacement
7.5	Airflow Calibration
7.6	Filter Integrity Check
7.7	Main Control Board Description and Replacement
Section No. 8.....	Error Messages, Troubleshooting and Option Diagnostics
Section No. 9.....	Polycarbonate Material Compatibility
Section No. 10.....	Remote Contacts
Section No. 11.....	Electrical/Environmental Requirements
Section No. 12.....	Disposal and Recycle
Insert.....	Replacement Parts List

Manual Drawings

ACD-15638.....	NU-813 Airflow Schematic
BCD-18729	NU-813/300 Specification Drawing
BCD-18730	NU-813/400 Specification Drawing
BCD-18731	NU-813/600 Specification Drawing
BCD-16521	NU-813 Control Panel
BCD-15639	NU-813 Bag-In/Bag-Out Filter Removal Procedure

Assembly Drawings

BCD-15640 (Sht. 1, 2, 3).....	NU-813 Assembly Drawings
BCD-17400	NU-813 Base Stand Telescoping
BCD-17401	NU-813 Base Stand Telescoping with Castors
BCD-15071	Fixed Range Duct Canopy

Electrical Schematics

BCD-16968	NU-813 Electrical Schematic (115 VAC)
BCD-16969	NU-813 Electrical Schematic (230 VAC)

LabGard® Containment Ventilated Enclosure

Model

NU-813-300/400/600

NU-813-300E/400E/600E

Portable Bench Top

MANUFACTURED BY:

NuAire, Inc. - Plymouth, Minnesota

1.0 General Information

1.1 Description

The LabGard® Containment Ventilated Enclosure (CVE) Model NU-813 is offered as a Class I Containment Enclosure equipped with a HEPA filter. In the Class I configuration, the NU-813 provides personnel protection for handling low risk aerosols and particulate matter. Room air enters the Enclosure, flowing past the operator into the work access opening providing an air barrier which minimizes contaminants generated within the enclosure work zone from migrating into the room. The air flows through the enclosure carrying contaminants with it, exiting through a HEPA filter.

1.2 Safety Instructions

These safety instructions describe the safety features of the LabGard® Model NU-813.

The CVE has been manufactured using the latest technological developments and has been thoroughly tested before delivery. It may, however, present potential hazards if it is not used according to the intended purpose or outside of operating parameters. Therefore, the following procedures must always be observed:

- The CVE must be operated only by trained and authorized personnel.
- For any operation of this unit, the operator must prepare clear and concise written instructions for operating and cleaning, utilizing applicable safety data sheets, plant hygiene guidelines, and technical regulations, in particular.
 - Which decontamination measures are to be applied for the cabinet and accessories
 - Which protective measures apply while specific agents or materials that are used
 - Which measures are to be taken in the case of an accident
- Repairs to the device must be carried out only by trained and authorized expert personnel.
- Keep these operating instructions close to the unit so that safety instructions and important information are always accessible.
- Should you encounter problems that are not detailed adequately in the operating instructions, please contact your NuAire Representative or NuAire Technical Service.

1.3 Explanation of Symbols



WARNING

WARNING indicated a potentially hazardous Situation which, if not avoided, could result in Death or serious injury.



CAUTION

CAUTION indicates a potentially hazardous Situation which, if not avoided, may result in Minor or moderate injury.

CAUTION

CAUTION used without the safety alert symbol Indicates a potentially hazardous situation which, if not avoided, may result in property damage.



Potential electrical hazard, only qualified person to access



Note:

Used for important information



Biohazard



Ground, Earth



Lead Free



Flammable Hazard





Hazardous Gases!
Personal Protection Equipment Required

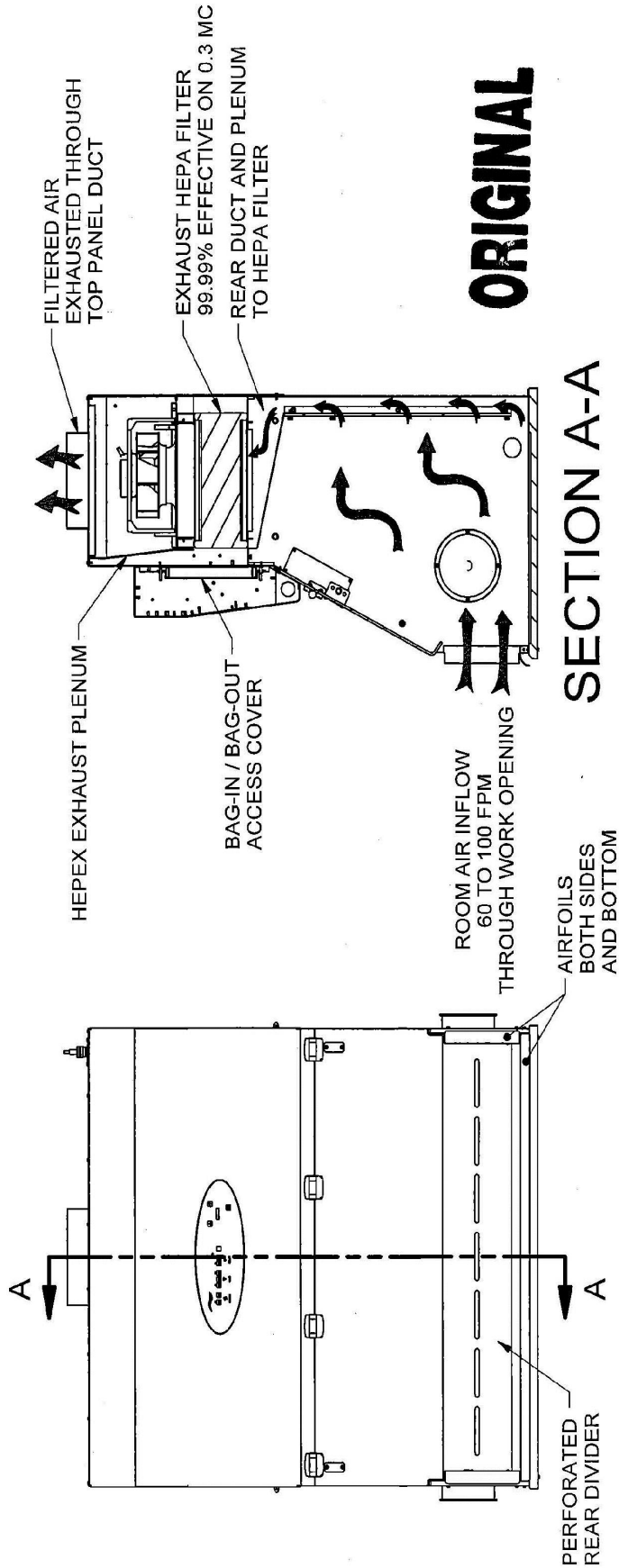

Chemical Hazard

REV	ECO	DESCRIPTION	DATE	DFTM	CHKD
A	11777	RELEASE TO PRODUCTION	10/22/2012	AW	MSS



	PROPRIETARY THE INFORMATION CONTAINED HEREIN IS THE EXCLUSIVE PROPERTY OF NUAIRE INC. AND IS NOT TO BE DIVULGED OR USED IN ANY MANNER WITHOUT THE EXPRESS WRITTEN PERMISSION OF NUAIRE INC.	
	DATE 10/16/2012 DFTM AW CHKD MSS	TITLE NU-813, SERIES 30 AIRFLOW SCHEMATIC
MATERIAL AS NOTED		PART ACD-15638
UNLESS OTHERWISE SPECIFIED DIMENSIONS ARE IN INCHES -TOLERANCES- DECIMALS ± .032 ANGLES ± 2°		PROJECT NUMBER SHEET 1 OF 1

2.0 Models & Features

The NU-813 comes in three standard size widths: 36" (914mm) (Model-300/300E)
48" (1219mm) (Model-400/400E)
72" (1829mm) (Model-600/600E)

REV	ECO	DESCRIPTION	DATE	DFTM	CHKD
C	13915	UPDATED VIEWS, CORRECTED / ADDED DIMENSIONS	1/7/2019	TH	MSS

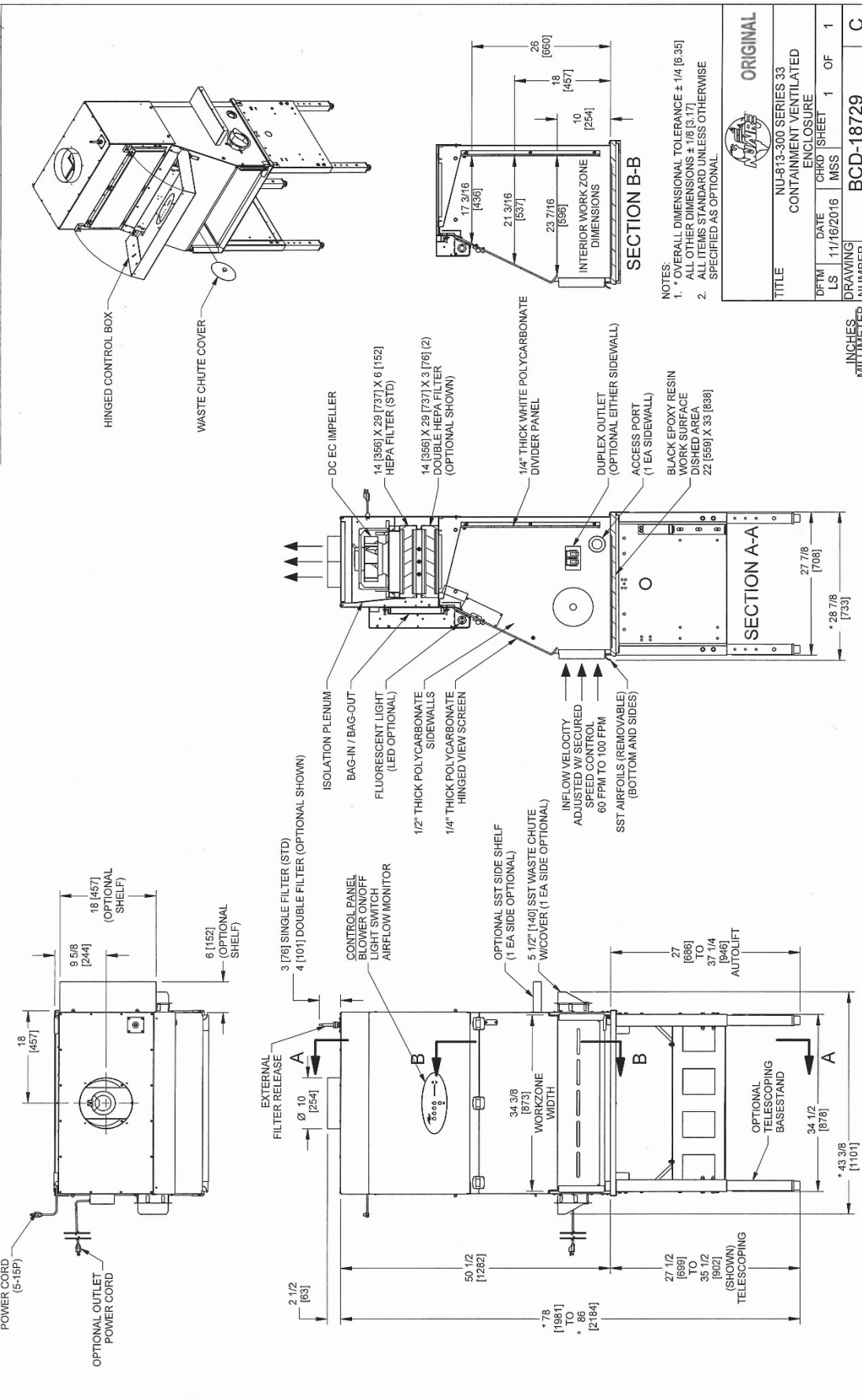

REV	ECO	DESCRIPTION	DATE	DFTM	CHKD
C	13915	UPDATED VIEWS, CORRECTED / ADDED DIMENSIONS	1/7/2019	TH	MSS

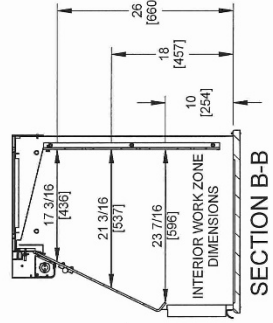
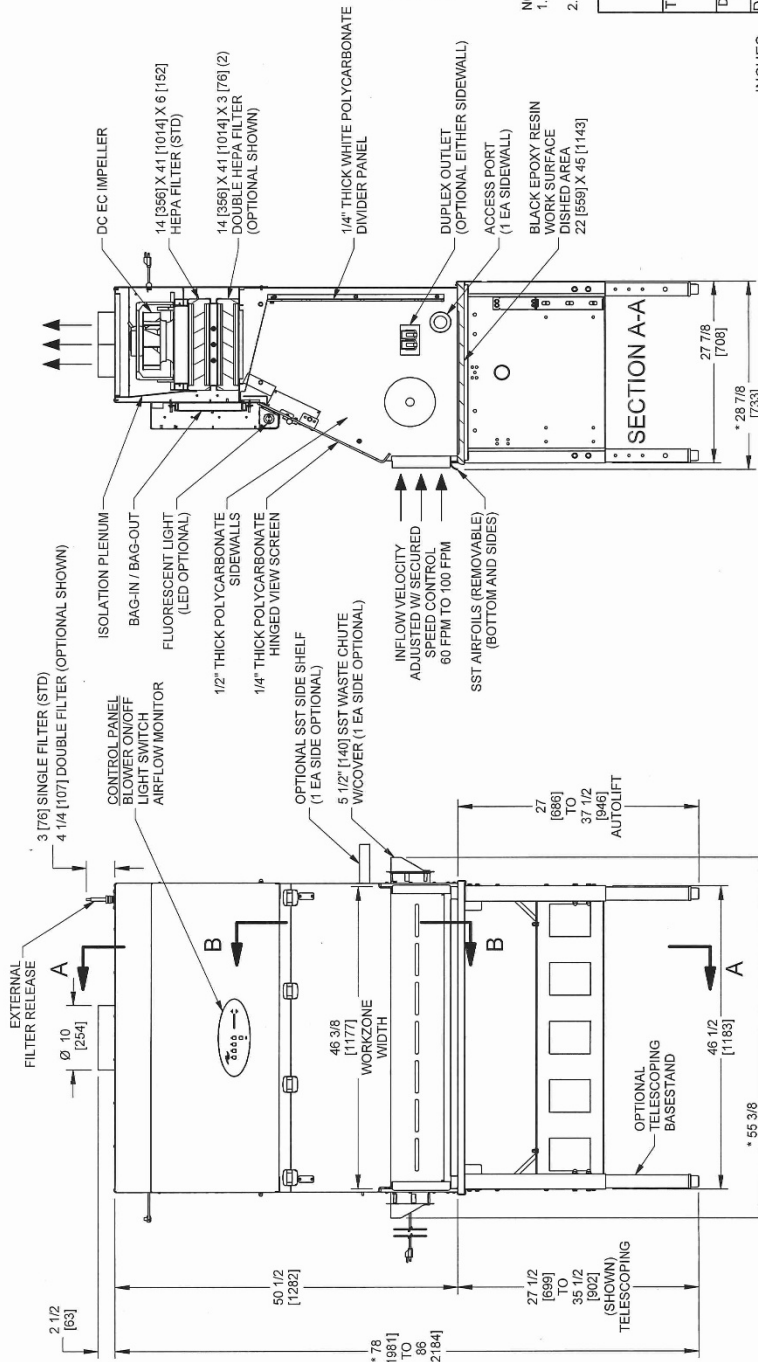
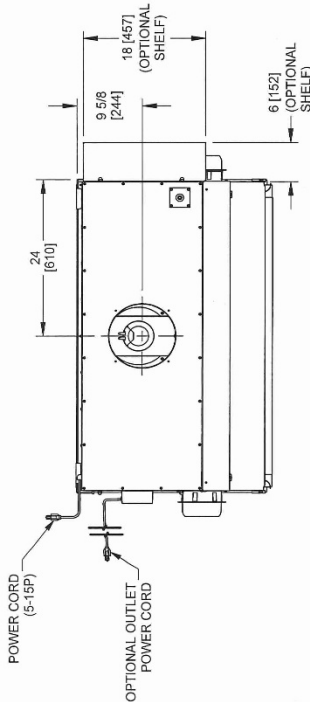
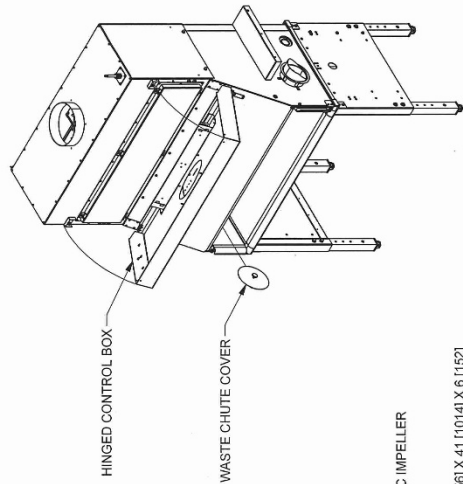

NOTES:
 1. * OVERALL DIMENSIONAL TOLERANCE ± 1/4 [6.35]
 ALL OTHER DIMENSIONS ± 1/8 [3.17]
 ALL ITEMS STANDARD UNLESS OTHERWISE SPECIFIED AS OPTIONAL

ORIGINAL	
TITLE NU-813-400 SERIES 33 CONTAINMENT VENTILATED ENCLOSURE	
DFTM	DATE
LS	11/16/2016
CHKD	MSS
SHEET	1 OF 1
DRAWING NUMBER	BCD-18730

INCHES
MILLIMETER

REV	ECO	DESCRIPTION	DATE	DFTM	CHKD
C	13915	UPDATED VIEWS, CORRECTED / ADDED DIMENSIONS	1/7/2019	TH	MSS

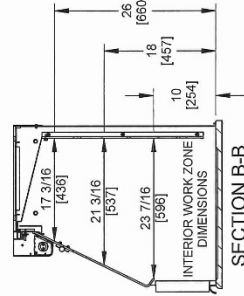
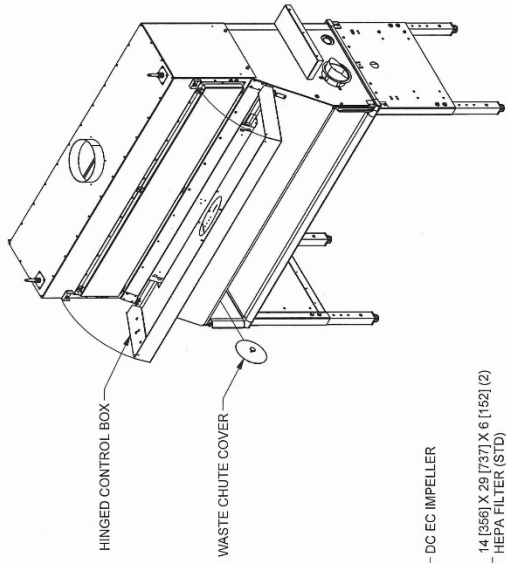

NOTES:
 1. * OVERALL DIMENSIONAL TOLERANCE ± 1/4 [6.35]
 ALL OTHER DIMENSIONS ± 1/8 [3.17]
 ALL ITEMS STANDARD UNLESS OTHERWISE SPECIFIED AS OPTIONAL.

ORIGINAL	
NU-813-600 SERIES 33 CONTAINMENT VENTILATED ENCLOSURE	
DFTM	DATE
LS	11/16/2016
MSS	1 OF 1
DRAWING NUMBER	BCD-18731

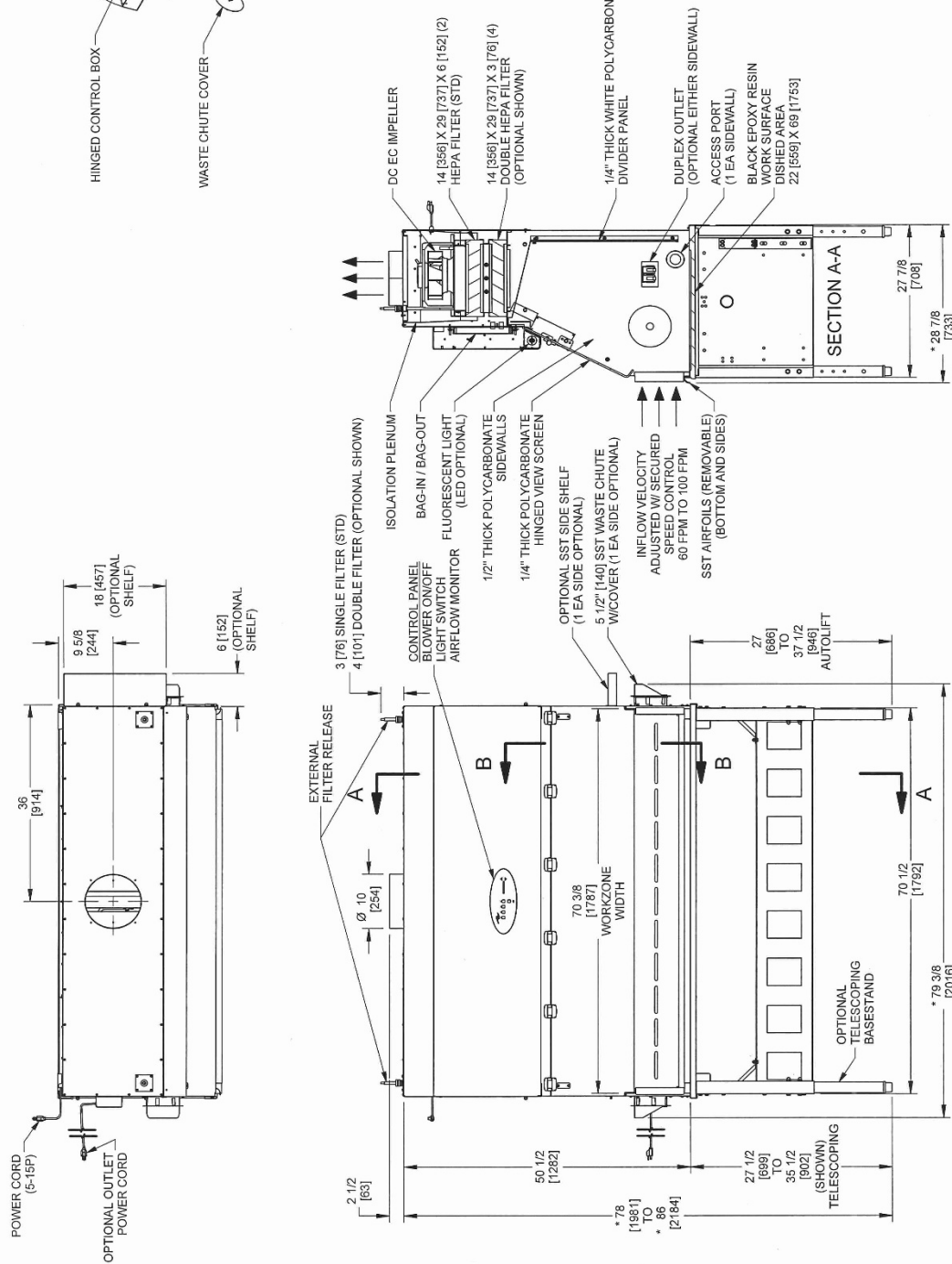

INCHES
MILLIMETER

3.0 Warranty

Details regarding product warranties can be found in the published warranty data separate from this manual and included within the data packet sent with the unit.

4.0 Shipments

NuAire takes every reasonable precaution to assure that your LabGard® CVE arrives without damage. Motor carriers are carefully selected and shipping cartons have been specially designed to insure your purchase. However, damage can occur in any shipment and the following outlines the steps you should take on receipt of a NuAire LabGard® CVE to be sure that if damage has occurred, the proper claims and actions are taken immediately.

4.1 Damaged Shipments

- 4.1.1** Terms are factory, unless stated otherwise. Therefore, it is important to check each shipment before acceptance.
- 4.1.2** If there is visible damage, the material can be accepted after the driver makes a notation on the consignee's copy of the freight bill. Then an inspection must be made to verify the claim against the carrier. This inspection is the basis of your filing the claim against the carrier.
- 4.1.3** If concealed damage is found, it is absolutely necessary to NOTIFY THE FREIGHT AGENT AT ONCE, and request an inspection. Without this inspection, the transportation company may not accept a claim for loss or damage. If the carrier will not perform the inspection, an affidavit must be prepared stating that he was contacted on a certain date and that he failed to comply with the request. This along with other papers in the customer's possession will support the claim.

5.0 Installation Instructions

5.1 Location

Within the laboratory, pharmacy, etc., the ideal location of the CVE is away from personnel traffic lanes, air vents (in or out), doors and/or any other source of disruptive air currents.

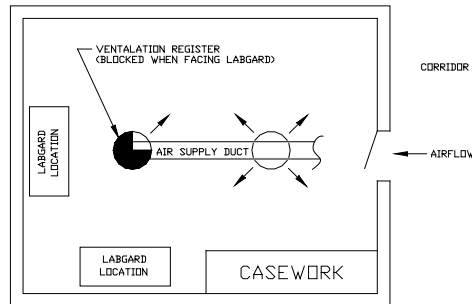

If drafts or other disruptive air currents exceed the intake velocity of the cabinet through the access opening, the potential exists for contaminated air to exit the cabinet. It depends on the severity of the air current. **REMEMBER: A CONTAINMENT CABINET IS NO SUBSTITUTE FOR GOOD LABORATORY TECHNIQUE.**

Where space permits, a clear 6 inch (152mm) area should be permitted on each side of the enclosure for maintenance purposes. The electrical outlet into which the CVE is connected should be readily accessible for maintenance purposes.

Do not position the cabinet to prevent access to the power cord. The power cord plug serves as the disconnect and should remain readily accessible. If the outlet is inaccessible, such as a conduit (hardwired) connection, then an appropriate warning label should be applied near the cabinets on/off switch to indicate the circuit breaker on the power distribution panel to be used.

5.2 Electrical Services

The NU-813 Series CVE may be "hardwired" (optional) or connected via an electrical power cord which is standard. The unit requires 115 VAC, 60 Hz or 230 VAC, 50 Hz depending upon model, single phase (current rating varies per cabinet size, reference Electrical/Environmental Requirements). It is recommended that power to the unit be on its own branch circuit, protected with a circuit breaker at the distribution panel.

 **Note: THIS UNIT CONTAINS ELECTRONIC BALLASTS FOR THE LIGHTING. ELECTRONIC BALLASTS OPERATE WITH HIGH INRUSH CURRENT. IT IS NOT RECOMMENDED TO USE THIS PRODUCT WITH GROUND FAULT CIRCUIT INTERRUPTERS (GFCI'S) BECAUSE THE BALLASTS MAY CAUSE THE GFCI TO TRIP.**

5.3 Final Assembly

REMOVE THE PROTECTIVE CARDBOARD COVER OVER THE EXHAUST OUTLET. The exterior surfaces are easily cleaned with any mild household detergent cleaner using a soft cloth. Harsh chemicals, solvent-type cleaners and abrasive cleaners should not be used.

Cabinet interior walls or work surface are easily cleaned with any mild household detergent cleaner using a soft cloth. Turn the CVE on and let it operate for 60 minutes before using.

5.4 Certification Testing Methods and Equipment

After installation and prior to use, NuAire recommends that the CVE be certified or commissioned to factory standards. At a minimum, the following tests should be performed.

1. HEPA filter leak test
2. Inflow velocity test
3. Airflow smoke patterns

The testing methods and equipment required are specified on the factory inspection report included with this manual (see insert in back cover).

 **NOTE:** IT IS RECOMMENDED THAT THESE TESTS BE PERFORMED BY A QUALIFIED TECHNICIAN WHO IS FAMILIAR WITH THE METHODS AND PROCEDURES FOR CERTIFYING LABORATORY CONTAINMENT EQUIPMENT (SEE INSERT).

 **NOTE:** AFTER THE INITIAL CERTIFICATION, NUAIRE RECOMMENDS THAT THE CABINET BE RECERTIFIED AT A MINIMUM ON AN ANNUAL BASIS AND AFTER EVERY FILTER CHANGE OR MAINTENANCE ACTION OR ANY TIME THE OPERATOR FEELS IT IS NECESSARY.

 **Note!** LabGard® CVE filters and seals provide premium performance; Quality Control in both design and manufacturing assure superior reliability. However, protection to both product and operator is so vital that certification to the performance requirements should be accomplished as stated to ensure safety established by the factory standards.

LabGard® Containment Ventilated Enclosure
Models NU-813-300/400/600/E

Catalog Number	Catalog Number		
	NU-813-300/E Nominal 3 foot (0.9m)	NU-813-400/E Nominal 4 foot (1.2m)	NU-813-600/E Nominal 6 foot (1.5m)
Performance Specifications 1. Personal Protection 2. Product Protection	ANSI/ASHRAE 110 NSF/ANSI 49 Surrogate Powder	ANSI/ASHRAE 110 NSF/ANSI 49 Surrogate Powder	ANSI/ASHRAE 110 NSF/ANSI 49 Surrogate Powder
NSF Std. No. 49 Class	Class I	Class I	Class I
Style of Cabinet	Bench top/console with optional base stand	Bench top/console with optional base stand	Bench top/console with optional base stand
Cabinet Construction	Polycarbonate panels with welded blower module.	Polycarbonate panels with welded blower module.	Polycarbonate panels with welded blower module.
HEPA Filter Seal Type: Exhaust Filter-99.995% Eff. on 0.3 microns	Neoprene, Spring loaded	Neoprene, Spring loaded	Neoprene, Spring loaded
Fumigation per NIH/NSF Procedure	Yes	Yes	Yes
Optional Services: Gas Cocks 3/8" NPT	Up to 3 ea. Sidewall	Up to 3 ea. Sidewall	Up to 3 ea. Sidewall
Cabinet Size Inches (mm): Height Depth Width	54 (1372) 29 (737) 36 (914)	54 (1372) 29 (737) 48 (1219)	54 (1372) 29 (737) 72 (1829)
Work Access Opening Inches (mm): Standard Opening Height/Optional Standard Inflow Velocity	8 (203) 80 FPM (.40 m/s)	8 (203) 80 FPM (.40 m/s)	8 (203) 80 FPM (.40 m/s)
Work Zone Inches (mm): Height Depth Width	28 (711) 24 (610) 34-3/8 (873)	28 (711) 24 (610) 46-3/8 (1178)	28 (711) 24 (610) 70-3/8 (1788)
Viewing window is ¼ in (6mm). clear polycarbonate	Closed: 8 (203) Open: 24 (610)	Closed: 8 (203) Open: 24 (610)	Closed: 8 (203) Open: 24 (610)
Noise: dbA Ambient Running	53 57	53 57	53 62
CFM @ 80 FPM	195 CFM	260 CFM	390 CFM
Heat Rejected, BTU, Per Hour (non-vented)	265	330	600
Electrical: 115V (230V) Volts, AC (Hz) Amps: Blower Amps: Lights Amps: Total 12 ft. Power Cord (one)	115 (230) / 50/60 1.6 (.8) .2 (.2) 1.8 (1.0) 14 GA - 3 Wire, 15A	115 (230) / 50/60 1.8 (.8) .2 (.2) 2.0 (1.0) 14 GA - 3 Wire, 15A	115 (230) / 50/60 3.2 (1.1) .4 (.2) 3.6 (1.3) 14 GA - 3 Wire, 15A
Crated Shipping Weight: *** Net Weight	350 lbs. / 159 kg. 300 lbs. / 136 kg.	450 lbs. / 204 kg. 400 lbs. / 181 kg.	550 lbs. / 249 kg. 500 lbs. / 227 kg.

***Crated shipping weight does not include weight for accessories or option

6.0 Operating the NU-813

6.1 Aeromax™ Control System

6.1.1 Overview

The Aeromax™ control system is designed to service the control requirements of the LabGard® ES NU-813 CVE. The Aeromax™ control system consists of an electronic module that will perform the following functions:

- Easy user interface via LED's and function keys
- Control blower via solid state switch.
- Control lights via solid state switch.
- Hinged window alarm
- Disable audible alarm switch with ring back function.
- Control blower DC EC Impeller with solid-state DC Motor Controller that provides automatic compensation for line voltage variances.
- Monitor and display airflow system performance via PresurFlow™ monitor.

The LabGard® ES NU-813 offers the latest digital microprocessor design technology for improved CVE performance and safety. The Aeromax™ control system integrates a digital pressure sensor (PresurFlow™) to monitor the CVE airflow performance. The Aeromax™ control system also integrates a DC EC Impeller controller that provides automatic compensation for both filter loading and line voltage variances. There is additional on/off control of blower and light. Lastly the Aeromax™ control system monitors the hinged window position with a micro switch. All the above functions are shown in a system block diagram (see figure 1).

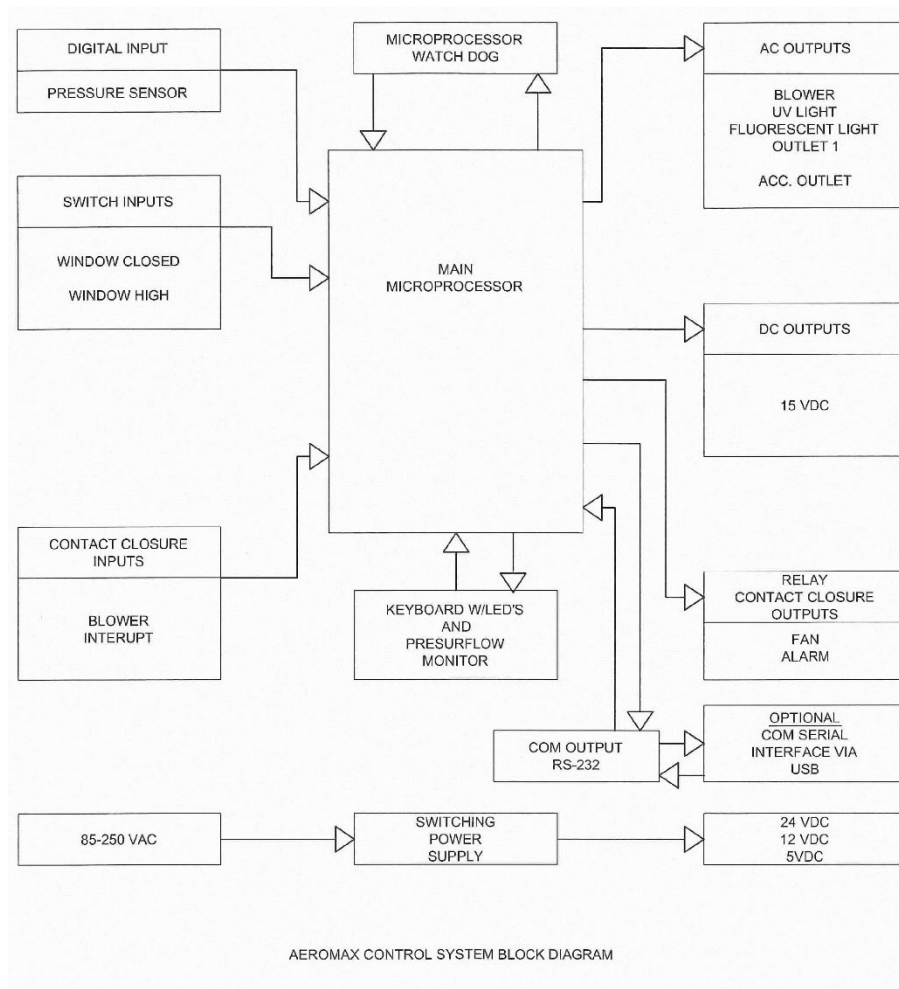
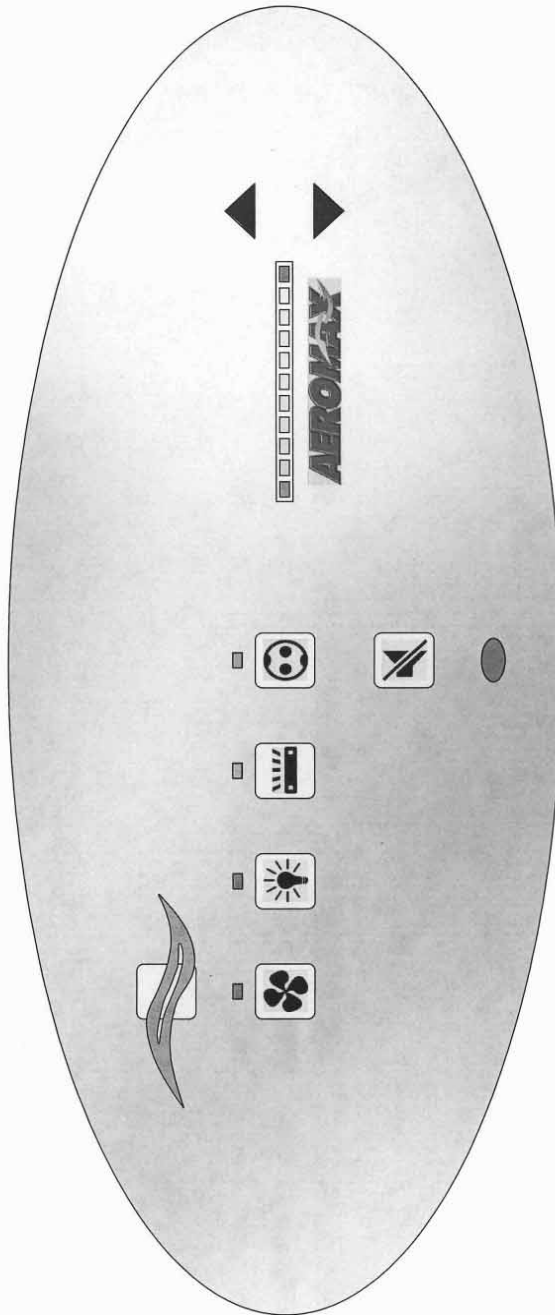



Figure 1

REV	ECO	DESCRIPTION	DATE	DFTM	CHKD
C	13471	UPDATED TITLE	8/25/2017	TH	BP



 ORIGINAL						
TITLE AEROMAX FRONT PANEL						
DFTM	DATE	CHKD	SHEET	1	OF	1
LS	12/16/2013	BP				
DRAWING NUMBER		BCD-16521				C

6.1.2 Front Panel

The control system front panel contains the following functions described in detail (see Drawing BCD-16521).

6.1.2.1 Blower Keys

The blower key controls the ON/OFF power to the blower.
LED above key indicates: full green for blower on,
blinking green for blower pending and
full red for blower alarm.

6.1.2.2 Hidden Key

The hidden key is located just above the blower LED indicator centered in the airflow symbol. The hidden key is used for various functions including the blower password 3 key sequence if the option is activated.

6.1.2.3 Fluorescent Light Key

The fluorescent light key controls the on/off power to the fluorescent light.
LED above the key indicates full blue for fluorescent light on.

6.1.2.4 Ultraviolet (UV) Light Key (Special Option Feature ONLY)

The UV light key controls the on/off power to the UV light (if optionally installed).
LED above indicates full yellow for UV light on.

6.1.2.5 Outlet Keys (Special Option Feature ONLY)

The outlet key controls the ON/OFF power to the outlets (If optionally installed).
LED above indicates full blue for outlets on.

6.1.2.6 Red Alarm LED

The red alarm LED will indicate any alarm condition and remain indicating until the alarm condition is cleared.

6.1.2.7 Audible Alarm Silence

The audible alarm silence key allows user interaction to silence an audible alarm for a period of 15 minutes.
After 15 minutes if the alarm condition still exists, the audible alarm will again sound.
The audible alarm silence key also is used to exit all Aeromax™ user interaction menus.

6.1.2.8 Arrow Adjustment Keys

The arrow adjustment keys allow user interaction for various functions.

6.1.3 Aeromax™ Control System Power

After the LabGard® ES NU-813 is plugged into the appropriate facility line power the control system will power up. The control panel will also indicate the power up status by blinking the red alarm LED. Pressing any key will acknowledge the power up status and turn off the blinking red alarm LED.

If a power interruption occurs, all control system functions, calibrations and parameters will be maintained and continue upon restoration of power. Just as the initial power up, the red alarm LED will blink to indicate power up status.

6.1.4 Standby Mode

When the CVE is not in use any of the function keys except the blower that initiates run mode may be turned on and off in standby mode.

6.1.5 Run Mode

Any time the blower run key is pressed with the hinged window at its correct operational height, the RUN MODE screen will be initiated. The Run Mode will start with the PresurFlow™ entering and approximate 3 minute warm up period. The PresurFlow™ LED indicators will blink and indicate the following sequence:

- 1st minute – Left and right Red LED's will blink
- 2nd minute – Left and right Green LED's will blink
- 3rd minute – Center 3 Green LED's will blink

Once the warm up period is complete, only one LED will indicate cabinet airflow status.

During the warm up period the cleaning process may begin. If the hinged window is raised, an audible and visual alarm will occur, but may be silenced by pressing the alarm silence key.

6.1.6 Temporary Low Flow Mode

The NU-813 may be configured to allow the airflow to be temporarily lowered, but still provide some level of protection for sensitive procedures. Typically, airflow in this mode is set to provide an average of 50 fpm versus the standard 80 fpm. If temporary low flow mode is configured (see section 8.2.2), the blower must be on (green LED above blower key will blink) and the window in its normal position. To activate, press the blower key for 5 seconds, once activated, blower LED indicator will blink fast and the PresurFlow™ will indicate 3 green LED indicators will blink. The low flow mode will stay active for the timed duration (normally 15 minutes as programmed, see 6.1.8.2) or can be terminated by pressing the blower key, for 5 seconds.

6.1.7 Standby/Run Mode Alarms

If present, standby/run mode alarms will be both visual and audible, the red alarm LED oval will turn on. Audible alarms will produce an alarm tone for 30 seconds, then ring back for 2 seconds of every 5 seconds. Pressing the alarm silence key will silence the audible alarm for 15 minutes initially then will start the ring back function again.

The list below represents alarm types and their respective priority from the highest to lowest priority.



- 1) New Firmware Loaded
- 2) Internal Board Failure
- 3) Power on Reset
- 4) Airflow Pressure Alarm
- 5) Blower RPM Failure
- 6) Window Open



 **Note:** The above messages are described in greater detail in section 8.

6.1.8 Operator Accessible Functions

6.1.8.1 Access and Navigation

To access the operator accessible functions,

- Press and hold the  key, then enter the 3 key sequence for the desired function, then release the  key and follow each instruction set.

 **Note:** Pressing the  key at any time will abort and exit the process without saving any changes made. Pressing the hidden key will accept all changes and exit.

6.1.8.2 Auto Timer Duration

Auto timer duration timers are countdown timers for the functions displayed once time is entered into a function. The timer will begin to countdown upon the start of that function (i.e. press UV light key to start timing the UV light). The LED indicator above the function key will start to blink indicating the timer function. If the LED indicator was full on, no timer function is present. As the timer expires the function will turn off.

- Select auto timer duration function

- Outlets

Press and hold  key, then press hidden – outlet – outlet keys sequentially.

LED indicator above outlet will blink fast. Adjust desired time as described below.

- Lights

Press and hold  key, then press hidden – light – light keys sequentially.

LED indicator above light will blink fast. Adjust desired time as described below.

- UV Light

Press and Hold  key, then press hidden – UV light – UV light keys sequentially.

LED indicator above UV light will blink fast.

Adjust desired time as described below.

- Low Flow Blower

Press and hold  key, then press hidden-blower-blower keys sequentially.

LED indicator above Blower key will blink fast. Adjust desired time as described below.

- Adjust countdown time

Press ↑ or ↓ keys to adjust time.

Time will change in 15 minute increments as shown on the PresurFlow™ LED segments below.



15 minutes for Red LED

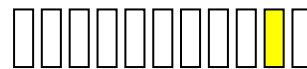

30 Minutes for Yellow LED



1 hour for green LED



Represents 8 hours (maximum time)

- Press hidden key to accept time and exit.
- Press  key at any time to abort and exit.

6.1.8.3 Blower Password

The blower on/off password allows the cabinet user to place a 3 key sequence requirement to turn the blower on or off.

The 3 key sequence for the blower password will be a combination of the hidden and blower keys.

- Select blower password

Press and hold  key, then press hidden – blower – hidden keys sequentially. Red LED indicator above blower will blink fast.

- Select password

Press \uparrow or \downarrow key to scroll through the code choices below,

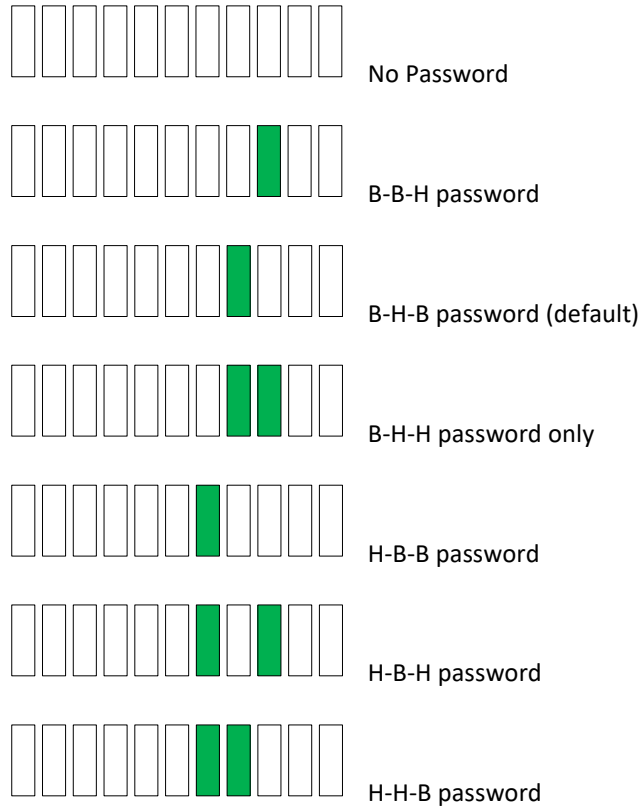

- Press hidden key to accept time and exit.
- Press  key at any time to abort and exit.

 **Note:** If the required blower password option is selected in the blower airflow option menu (see section 8.2.2). Then the “No password” choice above is not available and the default remains B-H-B.

6.2 Operating Guidelines

- 6.2.1** The intent herein is to present general operating guidelines that will aid in the use of the CVE to control airborne contaminants of low to moderate risk.
- 6.2.2** Procedure protocols defined in terms of the barrier of control concepts unique to the CVE must be developed in order to obtain a maximum potential for safety and protection. The pre-planning necessary to develop these protocols is based on several fundamental considerations, each of which will contribute to optimum benefits from the equipment:
- a. Minimize disruption of "air curtain"
 - b. Minimize room activity
 - c. Employ aseptic techniques

- 6.2.3** The minimum number of items necessary should be placed into the enclosure to prevent overloading, but the work should also be planned to minimize the number of times an operator's hands and arms must enter and leave the air curtain at the open face. The ideal situation is to have everything needed for the complete procedure place in the enclosure's workzone before starting, so that nothing need pass in or out through the air barrier at the face until the procedure is completed. This is especially important in working with moderate risk agents.

 **Note:** When working with agents of lower risk, it is not as important for all materials to be placed in the enclosure workzone before starting, or for the procedure to be completely finished before materials are removed. Also, the time period for a unit of work may be continued over a more extended period during which entries and withdrawals from the enclosure may be made.

6.2.4 Minimize Room Activity

Activity in the room itself should be held to a minimum. Unnecessary activity may create disruptive air currents as well as interfere with the work of the operator. A person walking past the front of CVE can cause draft velocities up to 175 fpm (.88 m/s), which are sufficient to disrupt the air barrier provided by the work access opening.

6.2.5 Employ Methodical Technique

The operator must not assume an attitude of "let the CVE do it". Properly used, the CVE will do an excellent job of containing viable or toxic agents. Normal laboratory contamination control procedures and basic methodical techniques are necessary to obtain maximum benefit from the CVE. This precaution is merely an extension of good laboratory technique as practiced on open bench tops. The good laboratory practices designed to minimize creating and/or release of aerosols to the environment should not be discontinued.

Items of equipment in direct contact with powders or etiological agents must remain in the cabinet until enclosed or until surface-decontaminated. Trays of discard work materials and other work aids must be covered or bagged before removal from the enclosure workzone (aluminum foil may substitute for fabricated covers).

If an accident occurs which spills or splatters suspensions of chemicals or etiologic agents around the work area, all surfaces and items in the enclosure workzone must be surface-decontaminated before being removed.

In brief, the consideration which should be made in order to obtain optimal personnel safety and product protection may be reiterated:

- a. Pre-plan the procedures carefully
- b. Minimize disruption of the "air curtain"
- c. Employ aseptic techniques

6.2.6 Operating Sequence

Start Up - Turn on CVE blower and lights, check air intake and exhaust portals of the unit to make sure they are unobstructed. Blower speed must only be readjusted by qualified maintenance technicians.

Allow blowers to operate for a minimum of 5 minutes before manipulations are begun in the CVE. If the filtered air exhausted from the unit is discharged into the room, as in some installations, an additional advantage is obtained from purification (filtration) of characteristic contributing to the quality of the laboratory environment, some owners of CVE leave them in operation beyond the time of actual use.

6.2.7 Wipe down for CVE Operation

The interior surfaces of the work space should next be disinfected by wiping them thoroughly with 70 percent alcohol or similar non-corrosive antimicrobial agent.

 **NOTE: DISINFECTANTS THAT USE CHLORIDES AND HALOGENS WILL CAUSE DAMAGE TO THE STAINLESS STEEL SURFACES IF PRESENT AND LEFT ON FOR LONG PERIODS OF TIME. IF THE DISINFECTANT USED CONTAINS CHLORIDES OR HALOGENS, RE-WIPE ALL SURFACES WITH 70% ALCOHOL OR SIMILAR NON-CORROSIVE ANTI-MICROBIAL AGENT TO PREVENT DAMAGE TO STAINLESS STEEL.**

6.2.8 Materials & Equipment

The apparatus and materials should next be placed into the enclosure workzone. Materials should be arranged so that clean and dirty (used) materials are well separated.

6.2.9 Perform work

The work can now be performed. The technician performing the work is encouraged to wear appropriate personal protective equipment (PPE), (i.e. a long-sleeved gown with knit cuffs, rubber gloves and appropriate respirator). This will protect the hands and arms from viable agent and chemical contamination. At a minimum, the hands and arms should be washed well with germicidal soap before and after work.

6.3.10 Terminal Purging & Wipe down

Following completion of the work, allow the cabinet to run for a 2-3 minute period without personnel activity to purge the unit. The decontamination of the interior surfaces should be repeated after removal of all materials, culture, apparatus, etc. A careful check should be made for spilled or splashed which may contaminate the work environment.

6.2.11 Shut Down

Turn off blowers and lights. Do not use CVE as a depository for excess laboratory equipment during period of non-operation.

6.3 Ergonomics

Ergonomics, the study or accommodation of work practices is extremely important for proper CVE usage and user health and safety. An evaluation of normal work practices should be performed with each user when working in a CVE. Evaluation criteria should be at a minimum:

- a. Proper user posture
- b. Effective workzone layout for work practice
- c. Vision or sightlines

For each of the above evaluation criterion, several aids may be supplied to accommodate the user.

- Ergonomic chair - A six-way articulating seat and back control for personalized adjustment to assure proper user posture. Be sure feet are resting on the floor, chair foot support or foot rest. Also be sure back is fully supported with proper chair adjustments.
- Forearm/elbow support - The cabinet is provided with a forearm support on the work access opening. Periodic mini-breaks during work practice should be taken resting forearm to avoid stress and fatigue.
- Effective workzone layout - Always prepare your work procedure to minimize reach to avoid neck and shoulder stress and fatigue. Rotating tables are optional to maximum workzone and minimize reach.

Vision and sightline - Always prepare your work procedure to eliminate glare and bright reflections on the window. Keep your window clean and sightlines clear to your effect workzone.

6.4 Cleaning Procedures

6.4.1 General

Cleaning laboratory equipment is important in terms of both functionality and general good housekeeping. The information provided below is intended to aid the development of facility Standard Operating Procedures (SOP's) for cleaning the equipment. It is strongly recommended that all cleaning materials used be tested and verified ~~both~~ in terms of both effectiveness and material compatibility before they are written into the cleaning SOP documentation.

a. The airflow blower should be operating during the cleaning process to maintain sterility and/or containment during the cleaning process.

b. Raise window to gain additional access if desired.

c. Apply appropriate cleaning material or surface disinfectant to surfaces. Most surface disinfectants require a specific contact time depending the materials used within the work zone. **CONSULT APPROPRIATE DISINFECTANT DOCUMENTATION FOR PROPER APPLICATION AND SAFETY PRECAUTIONS.**

c-1. Polycarbonate (Covestro® Makrolon®AR) has noted material compatibility concerns (see polycarbonate compatibility section). They recommend the use of Hydrogen Peroxide based materials such as the following:

- Steriplex SD
- Safetec surface wipes
- Peridox RTU

It is recommended to AVOID the use of cleaning materials that contain Chlorine, Quaternary Ammoniums and Phenol's.

If the polycarbonate is lightly scratched, it may be able to be polished out with Mirror Glaze Plastic Polish or similar.

Further information may be available from www.covestro.com

c-2. Stainless steel (type 304) has noted material compatibility concerns with Acids, Chlorides and Halogens. **IF THESE MATERIALS ARE USED AND ALLOWED TO BE LEFT ON THE STAINLESS STEEL SURFACE, OXIDATION AND DEGRADATION WILL OCCUR.** Only by re-wiping surfaces with either sterile water or 70% IPA will remove harmful materials from the stainless steel surface.

Further information is available at the following: http://www.parrinst.com/wp-content/uploads/downloads/2011/07/Parr_Stainless-Steels-Corrosion-Info.pdf

NOTE: NuAire does not offer any product warranty with respect to cleaning material compatibility. **USE AT YOUR OWN RISK!** The information provided above is from raw material suppliers and known general source documents for use to develop application cleaning SOP's.

6.4.2 Panel Removal for Powder Use

If the enclosure is used to contain powdered materials, periodically the work zone panels should be removed and cleaned. Use the following procedure for panel removal.



When removing contaminated interior panels, continue to operate the enclosure blower to maintain negative pressure. Use appropriate Personnel Protective Equipment (PPE) (i.e. face mask, gloves, Tyvek gown) to mitigate exposure.

- a. Open hinged window
- b. Remove (2) knurled screws on the top of the rear panel. Lower panel and clean surfaces. Once panel is clean, remove from enclosure.
- c. Remove top panel by pushing up and back. Allow front to swing down, then back of panel can be raised over side brackets. Again clean surfaces as required.
- d. Clean rear plenum surfaces as well as top surfaces. **Do not clean the HEPA filter surface.**
- e. Replace interior panels by reversing the process.

7.0 General Maintenance



All maintenance actions on this equipment must be performed by a qualified technician who is familiar with the proper maintenance procedures required including both certification and repair.

7.1 Decontamination

No maintenance should be performed on the interior of the LabGard® CVE (area behind access panels) unless the cabinet has been microbiologically decontaminated, is known to be biologically clean, or known to be chemically inert. Surface disinfection is performed as specified in the Cleaning Procedures section.



Hazardous Gases! Personal Protection Equipment Required.



Decontamination using hazardous gas, vapor or mist must be performed in accordance with the specifications of NSF/ANSI 49, Annex G, EN12469, Annex J or applicable national, state, province or local regulations

This procedure presents considerable risks and must be performed only by specially trained and authorized service personnel in accordance with applicable national safety regulations.

The decontaminate is generated either external or internal of the sealed cabinet. The quantity of decontaminate should follow standard or manufacturer's recommendations based on cabinet volume. The decontaminate process should follow standards or manufacturer's recommendations based on the decontaminate used.



All decontaminate materials are hazardous (chemical-liquid, gas and vapor) (Flammable – process) and are required to be handled properly. Follow all product and process documentation and labelling.

If microbiological decontamination is necessary, use the following procedure:

1. Place decontamination equipment inside the work area. Reference decontamination procedure, per NSF Standard 49, Annex G.

Cabinet Size	-300/E	-400/E	-600/E
Cabinet	21.3 cu.ft.	28.5 cu.ft.	42.8 cu.ft.
Volume	(.603 cu.m)	(.807 cu.m)	(1.212 cu.m)

2. Use duct tape and plastic to seal the entire cabinet.

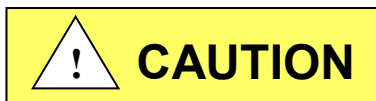

BE SURE THE CVE IS TOTALLY SEALED TO PREVENT ANY LABORATORY EXPOSURE TO DECONTAMINATION GAS.

Perform decontamination procedure per NSF Standard 49, Annex G.

7.2 Fluorescent Lamp Bulb Replacement

The one (T8) fluorescent lamp bulb is cool white, rapid start and placed external to the cabinet to aid maintenance and minimize heat build-up. The life rating of the bulb is 9000 hours based on three-hour burning cycles.

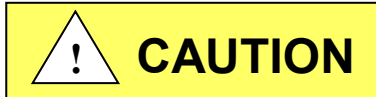

Disconnect electrical power from the CVE before attempting any maintenance action.

To replace a bulb, it is necessary to access the control panel.

1. Remove fasteners on top or sides of control panel and rotate control center down.
2. The lamp bulb is removed by displacing the bulb to one side against the compressible bulb holder.
3. Reverse the procedure to reinstall the lamp assembly.

7.3 HEPA Filter Replacement (Drawing BCD-15639)

The HEPA Filter under normal usage and barring an accident does not need replacement until the work access inflow velocity cannot be maintained.

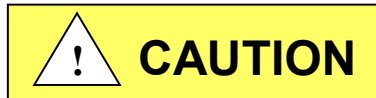

Disconnect electrical power from the CVE before attempting any maintenance action.

To access the exhaust HEPA filter:

1. Remove fasteners on top and sides of control panel and rotate control center down.
2. Remove exhaust filter cover and follow bag-in/bag-out procedure per drawing BCD-15639 for removal and replacement.
3. Reverse above steps to complete the replacement process.
- 4: Filter Installation

When installing new filters, USE ONLY NUAIRE SPECIFIED FILTERS FOR REPLACEMENT.

Description:	Exhaust HEPA Filter (Single)	Exhaust HEPA Filter (Dual)
Efficiency:	99.995% @ 0.3 Micron	99.995% @ 0.3 Micron
Airflow Rating:	100 fpm @ .29 ± .05" w.g. per sq. ft.	100 fpm @ .48 ± .05" w.g. per sq. ft.
Frame Type:	Metal	Metal
 NU-813-300/E		
NuAire Part Number:	A-980939-15	A-980939-20 (2)
Filter Size:	14" (356mm) x 29" (737mm) x 5-7/8" (149mm)	14" (356mm) x 29" (737mm) x 3" (76mm)
 NU-813-400/E		
NuAire Part Number:	A-980939-16	A-980939-21 (2)
Filter Size:	14" (356mm) x 41" (1041mm) x 5-7/8" (149mm)	14" (356mm) x 41" (1041mm) x 3" (76mm)
 NU-813-600/E		
NuAire Part Number:	A-980939-15 (2)	A-980939-20 (4)
Filter Size:	14" (356mm) x 29" (737mm) x 5-7/8" (149mm)	14" (356mm) x 29" (737mm) x 3" (76mm)

7.4 Motor/Blower Replacement

- 7.4.1** The Motor/Blower assembly should never need any preventative maintenance. But in case of a malfunction, the following steps should be taken. Make sure unit is decontaminated before doing any repairs on the interior of the unit. Disconnect power or unplug unit before working with any electrical wiring. Motor/Blower removal should be done by a qualified technician.
- 7.4.2** First, remove the top panel. Disconnect the electrical connections to impeller. Next remove impeller via fasteners. (See Drawing BCD-15640, Sheet 3).
- 7.4.3** To install motor/blower reverse the above procedure.

REV	ECO	DESCRIPTION	DATE	DFTM	CHKD
A	11777	RELEASE TO PRODUCTION	10/23/2012	AW	MSS

STEP 1:
 LOWER CONTROL BOX AND FILTER COVER.
 LOOSEN FILTER PRESSURE FRAME BY
 TURNING THE LEAD SCREW COUNTER-CLOCKWISE.
 USE THE ENCLOSED TOOL TO PRY AND LOOSEN FILTER.
 PULL THE OLD FILTER OUT INTO THE BAG.
 (NOTE: BE SURE BAG IS SECURELY ON FRAME. IF NEEDED,
 USE DUCT TAPE TO SECURE.)

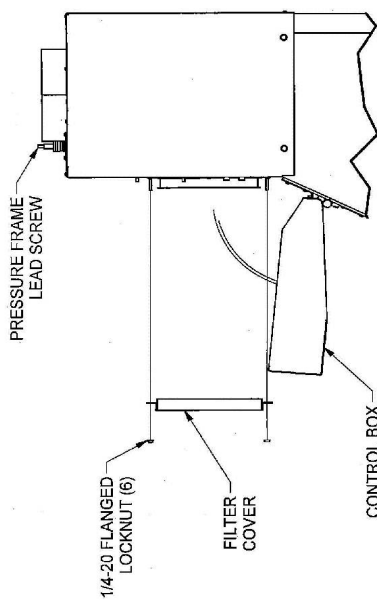

FIG. 1

STEP 2:
 HEAT SEAL OR WIRE TIE AT A POINT BETWEEN
 THE OLD FILTER AND THE BAG-INBAG-OUT FLANGE.
 HEAT SEAL OR WIRE TIED AREA SHOULD BE WIDE ENOUGH
 SO THAT WHEN THE BAG IS CUT WITH SCISSORS, THE SEAL
 REMAINS INTACT ON BOTH SIDES OF THE CUT.
 OR HEAT SEAL OR WIRE TIE 2 SEAMS AND
 CUT BETWEEN THE TWO.
 DISPOSE OF THE CONTAMINATED FILTER.
 RETAIN FILTER TOOL NEAR THE BAG-INBAG-OUT FRAME.

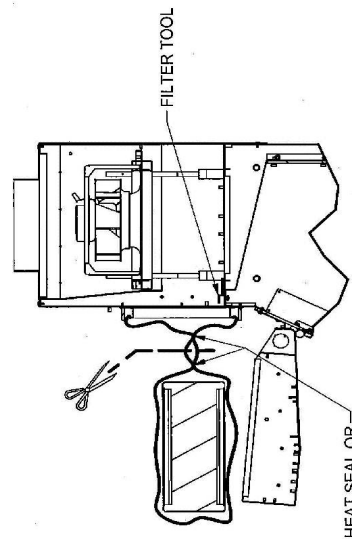

FIG. 2

STEP 3:
 PUT THE NEW FILTER IN A CLEAN PLASTIC BAG.
 BE SURE TO APPLY A LITTLE SILICONE GREASE TO THE
 FILTER GASKET BEFORE PUTTING IN THE PLASTIC BAG.
 SECURE THE NECK OF THE NEW BAG OVER THE OLD AND
 ONTO THE FLANGE OF THE BAG-INBAG-OUT RING.
 (NOTE: AGAIN, USE DUCT TAPE AS NECESSARY TO SECURE)

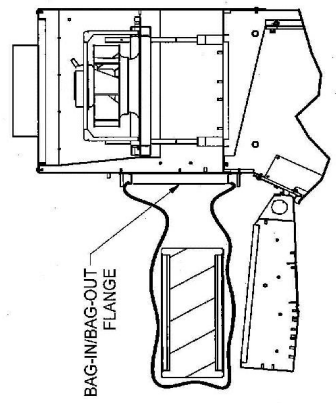

FIG. 3

OVERVIEW:
 THE BAG-INBAG-OUT PROCEDURE MAINTAINS A BARRIER
 BETWEEN THE OPERATOR AND DANGEROUS MATERIAL.
 THE CONTAMINATED FILTER CAN BE REMOVED FROM THE AREA
 AND A NEW FILTER INSTALLED WITHOUT EXPOSING PERSONNEL
 SEAL CHAMBER AND DECONTAMINATE PER NIH/NSF PROTOCOL
 BEFORE STARTING FILTER REPLACEMENT PROCEDURE.
 PLEASE NOTE THAT THE POLYETHYLENE BAG IS SECURED TO THE
 BAG-INBAG-OUT FLANGE WITH AN ELASTIC CORD.
 IT IS RECOMMENDED THAT DUCT TAPE BE ADDED TO THIS AREA TO
 AID IN HOLDING THE BAG ONTO THE BAG-INBAG-OUT FLANGE DURING
 THE EXHAUST FILTER REPLACEMENT PROCEDURE.
 REFER TO STEPS 1-4 FOR DETAILED INFORMATION.

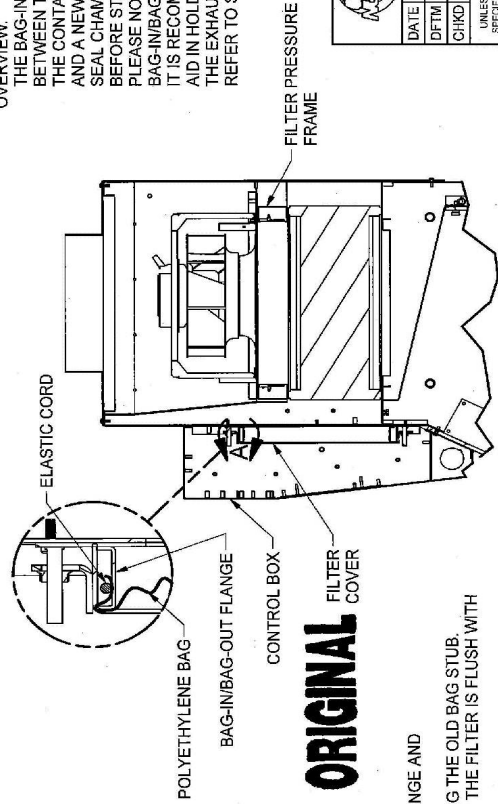

FIG. 4

STEP 4:
 PULL THE OLD BAG STUB AWAY FROM THE BAG-INBAG-OUT FLANGE AND
 WORK INTO THE REAR OF THE NEW BAG.
 HEAT SEAL OR WIRE TIE AND CUT OFF THE PORTION CONTAINING THE OLD BAG STUB.
 PUSH THE NEW FILTER INTO THE CABINET UNTIL THE FRONT OF THE FILTER IS FLUSH WITH
 THE FILTER PRESSURE FRAME.
 RE-CLAMP THE FILTER PRESSURE FRAME BY TURNING THE LEAD SCREW CLOCKWISE.
 FOLD THE NEW BAG INSIDE THE CAVITY AND REPLACE THE FILTER COVER.
 THE FILTER/SEAL INTEGRITY CHECK MAY NOW BE MADE.

FIG. 5

		PROPRIETARY THE INFORMATION CONTAINED HEREIN IS THE EXCLUSIVE PROPERTY OF NU-813, INC. AND IS NOT TO BE REPRODUCED OR USED IN ANY MANNER WITHOUT THE EXPRESS WRITTEN PERMISSION OF NU-813, INC.	
DATE	10/16/2012	TITLE	NU-813, SERIES 30 BAG-IN / BAG-OUT FILTER REPLACEMENT PROCEDURE
DFTM	AW	CHKD	MSS
UNLESS OTHERWISE SPECIFIED DIMENSIONS ARE IN INCHES		MATERIAL	AS NOTED
-TOLERANCES- DECIMALS ± .002 ANGLES ± Z		PART NUMBER	BCD-15639
		PROJECT NUMBER	
			SHEET 1 OF 1

7.5 Airflow Control System Setup and Calibration

7.5.1 General

The operation of the NU-813 CVE requires that the setup and calibration procedures be performed in order to certify or commission for usage. The setup and calibration procedures performed **ONLY BY THE CERTIFIER** ensure that setpoints are verified and that the airflow monitor sensor is calibrated to the correct values.

7.5.2 Configuration Parameters

Configuration parameters identify CVE motor type and size for proper performance characteristics.

- Select/Verify model and size (**Bold items represent default parameters**)

- Press and hold  key, then press blower – blower – blower keys sequentially. LED indicates above both blower (red) and UV light keys will blink fast.

Review cabinet model size and change if desired as described below

- Press \uparrow or \downarrow keys to scroll through the LED segment choices associated with model/size.

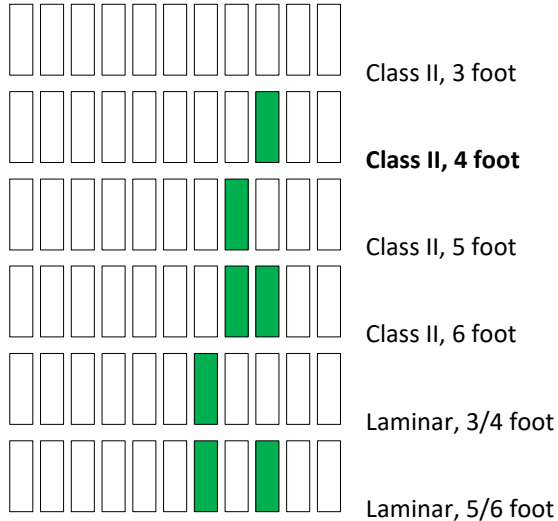

- Press hidden key to accept model/size and exit
- Press  key at any time to abort and exit

- Select motor control function/type

- Press and hold  key, then press light – light – light keys sequentially. LED indicators above both blower (red) and light keys will blink fast.

Review motor control function/type and change it desired as described below.

- Press \uparrow or \downarrow keys to scroll through the LED segment choices associated with motor control function/type.

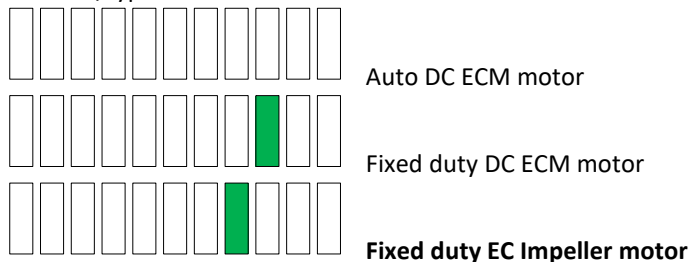

- Press hidden key to accept motor control function/type and exit
- Press  key at any time to abort and exit.

7.5.3 Airflow Calibration



Failure to calibrate airflow to the specified requirements may result in unsafe conditions of performance (i.e. product and/or personnel protection, noise and vibration)

The NU-813 Airflow Calibration consists of adjusting the airflow.

THIS WORK SHOULD BE DONE ONLY BY A QUALIFIED TECHNICIAN WHO CAN MEASURE THE AIRFLOW WITH A SUITABLE VELOMETER. NuAire provides one adjustment to set the airflow within the cabinet.

This is: PWM signal adjust via calibration parameter menu.

The PWM signal or blower speed adjustment establishes the CVE’s total volume of airflow as well as makes up for filter resistance tolerances.

DC ECM motor PWM signal DC voltage should also be monitored and recorded upon final calibration. The DC voltage may be measured using a digital voltmeter. The two test points to measure DC ECM motor voltage are located on the DC motor connector on the main control board.

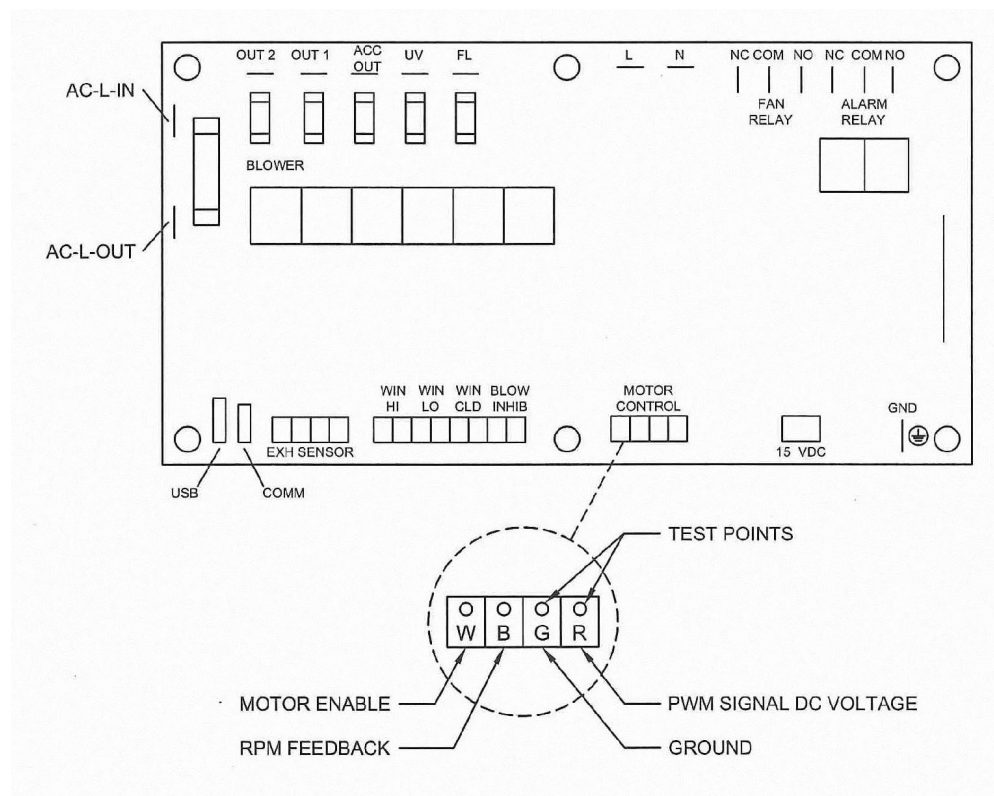

The CVE is considered to be certifiable if the following airflow measurements are present:

Inflow average: 80 LFPM \pm 5 LFPM (.41 m/s \pm 0.25 m/s) using the direct inflow measurement method or related value using the calculated inflow velocity measurement method.

BEFORE STARTING AIRFLOW CALIBRATION PROCEDURE, LET THE CVE RUN FOR AT LEAST 5 MINUTES.

7.5.3.1 Inflow Calibration

Step 1: Measure the inflow velocity using the recommended procedure found in Table 7.0. If necessary, adjust to achieve the correct average inflow velocity within the stated range of 80 ± 5 LFPM ($.41 \pm 0.25$ m/s).

Step 2: If necessary, enter active blower speed adjustment.

- Press and hold  key, then press hidden – blower - \uparrow keys sequentially. LED indicator above blower (green) key will blink fast.

Step 3: Press \uparrow or \downarrow keys to adjust blower speed.

- LED segments will indicate blower speed percentage and active blower speed adjustment



- Right end red LED indicates active blower speed adjust
The red LED will blink as soon as any adjustments are made and will continue to blink as the motor rpm settles. Once the red LED stops blinking, the motor will run steady state at the new percentage.

Note: The red LED must be non-blinking to save or exit

- Green LED's indicate percentage on of scale (0-100%)
- Yellow LED's indicate minimum (left/maximum (right) blower speed has been achieved

 **Note: At any time during the process**

- **Press hidden key to accept and enter the blower speed calibration point (If the blower speed calibration point was not successfully entered; a half second audible alarm will occur. The calibration process must then be repeated for successful entry of blower speed calibration point.)**
- Press  key to abort and exit

**Table 7.0
Recommended Measurement Methods for CVE Inflow**

A. Inflow/Velocity Measurement

- a. Instrument: Shortridge Flowhood ADM-870 or TSI 8355 Thermo anemometer.
- b. Procedure:
The inflow velocity is measured by using a Direct Inflow Measurement (DIM) Instrument (i.e. Shortridge flowhood).
The DIM Instrument can be used directly on the cabinet with NO CORRECTION FACTORS REQUIRED.
The DIM Instrument should also be duct taped to the cabinet to prevent any sneak air paths from occurring.

The DIM Instrument will read inflow volume (i.e. CFM).
Use the window access opening area to calculate inflow velocity.

Alternate Procedure

The calculated inflow measurement method may also be used.
Inflow air velocity is measured on a 4" by 4" (102mm by 102mm) grid in a vertical plane defined by the access opening.
Readings are taken 3" (76mm) from the top and bottom of the opening and 4" (102mm) from the sides.

- c. Test Data - Inches (mm):
DIM Measurement:

	300/E	400/E	600/E
Measured Intake Volume	ft. ³ /min. (m ³ /s)	ft. ³ /min. (m ³ /s)	ft. ³ /min. (m ³ /s)
Access Open Area	2.43 ft ² (.23 m ²)	3.26 ft ² (.3 m ²)	4.86 ft ² (.45 m ²)
Inflow Velocity	ft./min.(m/s)	ft./min.(m/s)	ft./min.(m/s)

Inflow Velocity Measurement - Inches (mm):

Front Access Opening

300/E	4 (102)	8 (203)	12 (305)	16 (406)	20 (508)	24 (610)	28 (711)	32 (813)									
400/E	4 (102)	8 (203)	12 (305)	16 (406)	20 (508)	24 (610)	28 (711)	32 (813)	36 (914)	40 (1016)	44 (1118)						
600/E	4 (102)	8 (203)	12 (305)	16 (406)	20 (508)	24 (610)	28 (711)	32 (813)	36 (914)	40 (1016)	44 (1118)	48 (1219)	52 (1321)	56 (1422)	60 (1524)	64 (1626)	68 (1727)
3 (76)																	
7 (178)																	

Number of Readings	Average Velocity	ft./min.(m/s)
--------------------	------------------	---------------

- d. Acceptance Criteria: Nominal velocity must average 75 to 85 fpm (.38 to .43 m/s)

7.5.3.2 PresurFlow™ Alarm Set Points

The PresurFlow™ alarm setpoints are based on the calibration setpoint. Once the calibration setpoint is entered, based on a nominal inflow velocity of 80fpm (.41mls) the associated pressure sensor value is entered as the nominal pressure value. **The high and low alarm setpoints are factory verified and set if needed at 60fpm (.30mls) and 100fpm (.51mls).**

However, if specific use alarm setpoints are desired, the alarm setpoints may be adjusted by performing the following:

Low Alarm Setpoint

- Press and hold the Hidden and ↓ key for 3 seconds.
(The left red LED will blink and the green LED's indicate blower speed)
- Press ↑ or ↓ keys to adjust blower speed to the desired airflow velocity low alarm setpoint value.



- Left end red LED indicates active low limit blower speed adjust
The red LED will blink as soon as any adjustments are made and will continue to blink as the motor rpm settles. Once the red LED stops blinking, the motor will run steady state at the new percentage. If the low alarm setpoint value is not within an acceptable range, the left end red LED will blink at a very fast rate.

Note: The red LED must be non-blinking to save or exit.



Note: At any time during the process

- Press hidden key to accept low alarm setpoint value
- Press and hold outlet key for three seconds to remove any previous offsets
- Press  key to abort and exit
- Upon exiting, the blower will go back to actual airflows.

High Alarm Setpoint

- Press and hold the Hidden and ↑ key for 3 seconds.
(The right red LED will blink and the green LED's indicate blower speed)
- Press ↑ or ↓ keys to adjust blower speed to the desired airflow velocity high alarm setpoint value.



- Red end Red LED indicates active high limit blower speed adjust.
The red LED will blink as soon as any adjustments are made and will continue to blink as the motor rpm settles. Once the red LED stops blinking, the motor will run steady state at the new percentage. If the high alarm setpoint value is not within an acceptable range, the right end red LED will blink at a very fast rate.

Note: The red LED must be non-blinking to save or exit.



Note: At any time during the process

- Press hidden key to accept low alarm setpoint value
- Press and hold outlet key for three seconds to remove any previous offsets
- Press  key to abort and exit
- Upon exiting, the blower will go back to actual airflows.





Note: Specific use alarm setpoints or the offset pressure value from the nominal calibration point will be maintained with a new nominal calibration value.
It is not necessary to re-enter the alarm setpoints after a nominal calibration.

7.5.3.3

Low Flow Calibration (See Section 8.2.2 to Activate the Low Flow Function)

The Nite Care mode is defaulted to operate the blower at approximately 600 rpm or a 14% duty cycle. However, if desired the Nite Care blower speed can be adjusted higher or lower by performing the following:

- Press and hold  key, then press hidden – blower - ↓ keys sequentially. LED indicator above blower (green) key will blink fast. Press ↑ or ↓ keys to adjust blower speed.
 - LED segments will indicate Nite Care blower speed percentage and active blower speed adjustment

 - Left end red LED indicates active blower speed adjust
The red LED will blink as soon as any adjustments are made and will continue to blink as the motor rpm settles. Once the red LED stops blinking, the motor will run steady state at the new percentage.
- Note: The red LED must be non-blinking to save or exit**
- Green LED's indicate percentage on of scale (0-100%)
 - Yellow LED's indicate minimum (left/maximum (right) blower speed has been achieved





 **Note: At any time during the process**

- Press hidden key to accept Low Flow blower speed calibration point
- Press  key to abort and exit

7.5.3.4

PresurFlow Alarm Verification

The PresurFlow Alarm setpoints are based on the calibration setpoint. Once the calibration setpoint is entered, the Alarm setpoint offset pressure values will align from the calibration pressure value. The high or low alarm setpoint can be verified by measuring inflow volume/velocity while adjusting blower up or down within the Alarm Verification menu.

- Press and hold  key, then press ↑ ↓ ↑ sequentially releasing the  key after the 3 key sequence.
- Note: If blower was off while entering into the Alarm Verification Menu, the low alarm limit will immediately activate. Turn on blower; once airflow is above the low alarm limit, the alarm will turn off.
- LED segments will indicate blower speed percentage.

- Press ↑ or ↓ key to raise or lower blower speed. Alarm is active so yellow and red LED's will activate if pressure reaches the low or high alarm limit.
- Press  to exit (blower should turn off and not go through normal start up procedure).

7.6 Filter Integrity Check

The filter must be scan tested before installation into the CVE. Once installed, an internal reference leak test can be performed to assure a proper installation was performed. Challenge aerosol (One Laskin Nozzle, PAO) should be supplied in the rear center of the workzone and the exhaust probed above the ring. When probing, a leakage shall not exceed 0.005% of the upstream concentration.

Internal reference concentration with one Laskin Nozzle open should be:

Laskin Nozzle Concentration Formula

$$\frac{\# \text{ Nozzles} \times 135 \text{ CFM} \times 100 \text{ ug/L}}{\text{Inflow (CFM)}} = \text{Challenge Concentrations (ug/L)}$$

$$\frac{\# \text{ Nozzles} \times 229 \text{ CMH} \times 100 \text{ ug/L}}{\text{Inflow (CMH)}} = \text{Challenge Concentrations (ug/L)}$$

Size	Airflow FPM (m/s)		
	60 (.30)	80 (.41)	100 (.51)
	Challenge (ug/L)		
300/E	93	69	56
400/E	69	52	41
600/E	46	35	28

7.7 Main Control Board Description and Replacement

To access the main control board for fuse or board replacement, remove screws at each upper side of the control center and allow the control center to rotate down, resting on the safety straps. Now the main control board is exposed for service.

7.7.1 Main Control Board Replacement

The main control board consists of one Printed Circuit Board (PCB) assembly.

The PCB contains the power supply, configuration switch, sensor inputs/outputs and control inputs/outputs components and display.

7.7.2 Main Control Board Fuse Replacement



Disconnect electrical power from CVE before fuse replacement.

All AC circuits are fuse protected and when replacement is necessary, USE ONLY FUSES OF SAME TYPE AND RATING FOR PROTECTION AGAINST RISK OF FIRE.

DESCRIPTION:	BLOWER FUSE	OUTLET FUSE (Option Only)	ACCESSORY OUTPUT FUSE (Option Only)	LIGHT FUSES
FUSE TYPE:	TIME-LAG	TIME-LAG	TIME-LAG	TIME-LAG
FUSE SIZE:	1/4 X 1-1/4 INCH	5 X 20MM	5 X 20MM	5 X 20MM
NU-813-300/E	3 AMPS	3 AMPS	2 AMPS	1 AMP (2)
NU-813-400/E	3 AMPS	3 AMPS	2 AMPS	1 AMP (2)
NU-813-600/E	5 AMPS	3 AMPS	2 AMPS	1 AMP (2)

7.7.3 Main Control Board Replacement

Note: All setup and calibration data will be lost, the memory reinitialized to the default values and all control functions reset to an initial cabinet power condition.

If possible, before the main control board replacement, it would be preferred to know the operational parameters of the cabinet, (i.e. blower speed/PWM signal DC voltage setpoints if modified and airflow data from previous certification).

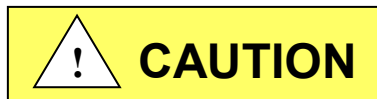

Disconnect electrical power from the CVE before attempting any maintenance action.

The main control board is fastened to the control center with (6) 6-32 studs/nuts. All electrical connections are made with removable terminals and/or Faston connectors except for the motor/blower connector which uses a screw terminal. Remove all electrical connections and fasteners and then remove the main control board from the control center.

Install new main control board by reattaching all electrical connections and fasteners. Once installed, rotate control center to normal position and fasten in place. Reconnect power to cabinet.

813 Dual HEPA Filter Testing

The NU-813 (Series 30) with the double HEPA filter option requires additional HEPA filter integrity testing. The additional HEPA filter integrity tests are performed by accessing the ports behind the control box.



**THESE PORTS ARE UNDER POSITIVE PRESSURE,
SO ACCESS SHOULD ONLY BE MADE WITH THE BLOWER OFF.**

The access port **Labeled S** is connected to a sample tube which runs between the two filters. The purpose of this port is to measure the primary HEPA filter's integrity with a photometer.

When using a photometer to gross leak test the primary HEPA filter, the leakage shall not exceed .005% of the upstream concentration. A similar technique may be used for a particle counter using the applicable methods and techniques.

For the primary HEPA the P.A.O. challenge is introduced into the cabinet workzone and the sample probe is taken from the port labeled S on the unit behind the control box.



P.A.O. challenge introduced into cabinet workzone center rear wall



Gross leak sample taken from the primary HEPA filter



P.A.O. challenge introduced

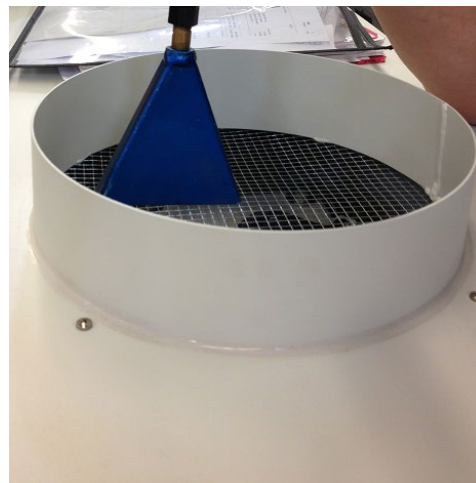

Probing exhaust airstream

The secondary HEPA filter may also be gross leak tested using the secondary filter P.A.O. supply port **Labeled C** to supply a P.A.O. challenge to the filter. An internal reference must be used instead of measuring upstream concentration. Normal gross leak testing techniques may then be used to verify filter integrity of the secondary HEPA.

For the secondary HEPA the challenge is introduced into the port labeled C on the unit. The probe sample is taken at the outlet of the unit along the protective screen

A third test shall be performed to verify the integrity of the seal of the cabinet itself. The same internal reference is used. The challenge is introduced into the workzone and the exhaust airflow if probed. The leakage shall not exceed .005%.

8.0 Error Messages, Troubleshooting, Option-Diagnostics and Airflow Sensor Performance Verification

Audible alarms and error messages occur for a variety of reasons. Whenever an alarm condition has been present for a period of at least 10 seconds, the audible alarm/error message will be presented and stay on until the error is cleared. The audible alarm will be on for 30 seconds upon initial alarm condition, then once every ten seconds. When presented with an error message, please perform the following:

Step 1: NOTE ALL ERROR MESSAGES.

Error message will appear on the control panel with red LED's.

Step 2: VERIFY ERROR MESSAGES.

Error messages can be verified by clearing the error function by either turning the blower or the cabinet on and off.

Step 3: MONITOR RE-OCCURRENCE OF ERROR MESSAGES.

If re-occurrence of the error message is immediate or daily, use the following guide to correct the situation.

8.1 Error Message Troubleshooting Guide

Issue	Error Description	Correction
– Window Alarm (Window High)	Hinged window is above standard working height or micro switch is not operating properly.	Verify standard working height and window micro switch operation.
Cabinet fluorescent lights won't Turn on	Blue LED above light key indicates the lamp should be on.	Check light fuse on main control board. Check fluorescent lamps. Check voltage coming out of main control board to light ballasts. Check light starters, if present. Check ballast.
Cabinet blower won't turn on.	Green LED above blower key indicates the blower should be on. Airflow Alarm.	Check blower fuse on main control board. Check AC voltage coming out of main control board. Check wiring to blower. Check blower motor. Check DC motor PWM signal on main control board.
Red alarm LED blinks	Indicates a power interruption has occurred.	Press any key to clear.
Blower or light fuse continues to blow after replacement.	N/A	Check for short on output of fuse. Isolate output of fuse by disconnecting control center connectors, light circuit, AC or DC blower circuit, etc. to isolate the short.
PresurFlow™ left red LED indicator on and red LED alarm	PresurFlow™ reading low flow (pressure)	Check airflow values. Check blower function. Recalibrate PresurFlow™ system.
PresurFlow™ right red LED indicator on and red LED alarm	PresurFlow™ reading high flow (pressure)	Check airflow values. Recalibrate PresurFlow™ system.
All PresurFlow™ LED's blink	Message acknowledges new firmware was loaded into microprocessor	N/A
Blower red LED blinks and red LED alarm	Indicates that the motor rpm signal has been interrupted	Check connectors and wires from main control board to the motor Replace motor if required

8.2 Option Parameters

The option parameter menu allows **A QUALIFIED TECHNICIAN** to configure several different optional parameters per the menu as described below.

8.2.1 Sync Function with Active Blower

To access the option parameter menu, perform the following:

- Press and hold  key, then press hidden - Blower - Fluorescent keys sequentially. Red LED indicator above the blower key will blink fast

The PresurFlow™ blinking green LED segments will indicate seven optional parameters as shown and described below. The UV Light key (move left) and outlet key (move right) allows selection of the option parameter desired.

Once the desired option parameter is indicated, press \uparrow or \downarrow key to turn on or off. A slow blinking green LED indicator means off and a fast blinking green LED indicator means on. Multiple option changes can be selected.

- Pressing the hidden key will accept all changes and exit
- Pressing the  key will abort the process and exit

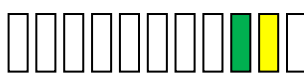

Sync Fan Relay with Active Blower -

Normally the fan relay will activate when the blower switch is pressed. Blower can either be actively running or pending. If the fan relay sync is active the blower must be actively running for the relay to change state.



Sync Accessory Outlet with Active Blower -

Normally the accessory outlet is on all the time. If the accessory outlet sync is active, the blower must be actively running for the accessory outlet to turn on.



Sync Outlet Power with Active Blower -

Normally the outlet power is turned on via the outlet key. If the outlet power sync is active, the outlet power will turn on and off with the blower or may be turned on and off independently if the blower is active.



Sync Fluorescent Light with Active Blower -

Normally the fluorescent light is turned on via the fluorescent light key. If the fluorescent light sync is active, the fluorescent light will turn on and off with the blower or may be turned on and off independently if the blower is active.



Sync 15 Volt DC output with active blower normally the 15 Volt DC output located on the control board is on when power is applied to the system. If the 15 Volt DC output sync is active, the blower must be actively running for the 15 Volt DC output to turn on.

8.2.2 Blower/Airflow Options

To access the option parameter menu, perform the following:

- Press and hold  key, then press hidden - \uparrow and \downarrow keys sequentially. Red LED indicator above the blower key will blink fast

The PresurFlow™ blinking green LED segments will indicate seven optional parameters as shown and described below.

The UV Light key (moves left) and outlet key (moves right) allows selection of the option parameter desired.

Once the desired option parameter is indicated, press \uparrow or \downarrow key to turn on or off. A slow blinking green LED indicator means off and a fast blinking green LED indicator means on. Multiple option changes can be selected.

- Pressing the hidden key will accept all changes and exit

- Pressing the  key will abort the process and exit

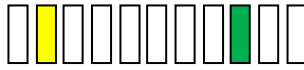

Require Password –

Normally it is not required to use a password (i.e. 3 key press sequence of the blower and hidden key). If the option is turned on, it would be required to use the correct password to turn on the blower. The default password once turned on is blower-hidden-blower keys in sequence. The password can be changed in the blower password option menu.

Note: If turning off the password option, you must also select the no password menu item (see section 6.1.8.3)

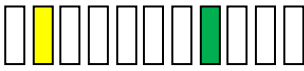

Allow UV light anytime –

Normally the UV light is interlocked with the window being in the closed position. For service purposes only, if the function is active, the UV light may be turned on at any window height.

 **Note:** In addition to the Allow UV light anytime system function, there is a double redundant UV light window interlock relay. To override the UV light window interlock relay, the relay itself must also be shorted. (See electrical schematic for reference).



Manual Blower Restart –

Normally when the blower is actively running and a power interruption occurs. The blower will automatically come back on when power is restored. If this function is turned off, the blower will not automatically come back after a power interruption, but would require the user to press the blower key to restart the blower.



Low Flow –

Normally the function is turned off. If selected and turned on, once the blower is actively running. Upon closure, the blower will continue to run at a calibrated lower speed level to maintain a negative airflow. The PresurFlow™ will indicate(s) blinking green LEDs along with green LED above blower key.



Disable PresurFlow™ -

If this function is active, the digital pressure sensor and alarm function are turned off.



Temporary Low Flow -

When this option parameter is turned on and the other requirements below are met, the blower key (when held for 5 seconds) will toggle blower between normal and Low Flow blower speed. The Low Flow blower will time out, based on the Auto Timer duration for Low Flow without a blower key press and the blower speed will revert back to normal.

In addition to turning this option on the following requirements must also be met

- Temporary Low Flow Option must be selected
- Password Option must be selected
- Window is at normal height and blower is running
- Low Flow Option must be selected
- Low Flow blower auto timer must be set for a minimum of 15 minutes.



Disable audible alarms / audible key feedback

Normally audible alarms from the PresurFlow™ monitor and audible key feedback are present to provide an audible sound to the user. If this function is active, all audible sound will be silenced when the control system is in normal run mode. Audible sound will still occur in any service/calibration menu function.

Environmental resistance of Makrolon® polycarbonate sheet

Makrolon® POLYCARBONATE SHEET IS RESISTANT AT 70°F AND 0% STRAIN TO:

CHEMICALS:

Amyl Alcohol	Chromic Acid (20%)	Lactic Acid (20%)	Potassium Bromate	Sodium Chloride
Aluminum Chloride	Citric Acid (40%)	Magnesium Chloride	Potassium Bromide	Sodium Hypochlorite
Aluminum Sulfate	Copper Chloride	Magnesium Sulfate	Potassium Nitrate	Sodium Sulfate
Ammonium Chloride	Copper Sulfate	Manganese Sulfate	Potassium Perchlorate	Stannous Chloride
Ammonium Nitrate	Formic Acid (10%)	Mercuric Chloride	Potassium Permanganate	Sulfur
Ammonium Sulfate	Formalin (30%)	Nickel Sulfate	Potassium Persulfate	Sulfuric Acid (10%)*
Antimony Trichloride	Glycerine	Nitric Acid (10%)	Potassium Sulfate	Sulfuric Acid (50%)
Arsenic Acid	Heptane	Nitric Acid (20%)	Silicone Oil	Tartaric Acid (30%)
Butyl Alcohol	Hydrochloric Acid (10%)	Oleic Acid	Silver Nitrate	Zinc Chloride
Calcium Nitrate	Hydrogen Peroxide (30%)	Oxalic acid	Sodium Bicarbonate	Zinc Sulfate
Chlorinated Lime Paste	Hydrofluoric Acid (10%)	Pentane	Sodium Bisulfate	
Chrome Alum	Isopropanol	Phosphoric Acid (10%)	Sodium Carbonate	

*Sulfuric Acid at 1% attacks polycarbonate sheet

COMMON HOUSEHOLD MATERIALS Makrolon® POLYCARBONATE IS RESISTANT TO:

CHEMICALS:

Borax	Joy Liquid Detergent	Rum
Cocoa	Insulating Tape	Salad Oil
Cement	Linseed Oil	Salt Solution (10%)
Chocolate	Liquor	Soap (Soft/Hard)
Cod Liver Oil	Milk	Table Vinegar
Cognac	Mineral Water	Tincture of Iodine (5%)
Coffee	Mustard	Tomato Juice
Detergents	Olive Oil	Vodka
Fish Oil	Onions	Washing Soap
Fruit Syrup	Orange Juice	Water
Grapefruit Juice	Paraffin Oil	Wine
Gypsum	Rapeseed Oil	

PETROLEUM PRODUCTS Makrolon® POLYCARBONATE SHEET IS RESISTANT TO:

Compressor Oil	Spindle Oil
Diesel Oil	Transformer Oil
Kerosene	Vacuum Pump Oil
Refined Oil	

Note: Elevated temperature and/or strain significantly alters resistance to industrial petroleum products.

LIMITED RESISTANCE AT 70°F AND 0% STRAIN TO:

Antifreeze	Hydrochloric Acid (conc.)
Calcium Chloride	Milk or Lime (CaOH)
Cyclohexanol	Nitric Acid (conc.)
Ethylene Glycol	Sulfuric Acid (conc.)

Makrolon® POLYCARBONATE SHEET IS NOT RESISTANT TO:

CHEMICALS:

Acetaldehyde	Benzyl Alcohol	Chlorobenzene	Formic Acid (conc.)	Phosphorus Trichloride
Acetic Acid (conc.)	Brake Fluid	Chloroethene	Freon (refrigerant/propellant)	Propionic Acid
Acetone	Bromobenzene	Cutting Oils	Gasoline	Sodium Sulfide
Acrylonitrile	Butylic Acid	Cyclo Hexanone	Lacquer Thinner	Sodium Hydroxide
Ammonia	Carbon Tetrachloride	Cyclohexene	Methyl Alcohol	Sodium Nitrate
Ammonium Fluoride	Carbon Disulfide	Dimethyl Formamide	Nitrobenzene	Tetrahydronaphthalene
Ammonium Hydroxide	Carbolic Acid	Ethane Tetrachloride	Nitrocellulose Lacquer	Thiophene
Ammonium Sulfide	Caustic Potash Sol. (5%)	Ethylamine	Ozone	Toluene
Benzene	Caustic Soda Sol. (5%)	Ethyl Ether	Phenol	Turpentine
Benzoic Acid	Chloride	Ethylene Chlorohydrin	Phosphorus Hydroxy	Xylene

Makrolon® POLYCARBONATE SHEET IS DISSOLVED BY:

Chloroform, Cresol, Dioxane, Ethylene Dichloride, Methylene Chloride, Pyridine

EFFECTS OF MOISTURE ON Makrolon® POLYCARBONATE SHEET:

Makrolon Polycarbonate Sheet has good resistance to water up to approximately 150°F. Above this temperature, the effect of moisture is time-temperature related. Exposing Makrolon Polycar-

bonate Sheet to repeated steam cleaning or dishwashing can create hydraulic crazing. The result can be a clouding of the surface and ultimately a loss of physical strength properties.

10.0 Remote Contacts

The NU-813 has several contact closures for remote sensing of various functions.

10.1 Fan Relay

The fan relay contacts are normally open and closed contact closure outputs that are activated whenever the blower key is pressed and the blower key LED indicator is on or blinking. Contact ratings are 250 VAC maximum at 2 Amps.

10.2 Alarm Relay

The alarm relay contacts are normally open and closed contact closure outputs which are activated whenever an airflow alarm condition occurs. Contact ratings are 250 VAC maximum at 2 Amps.

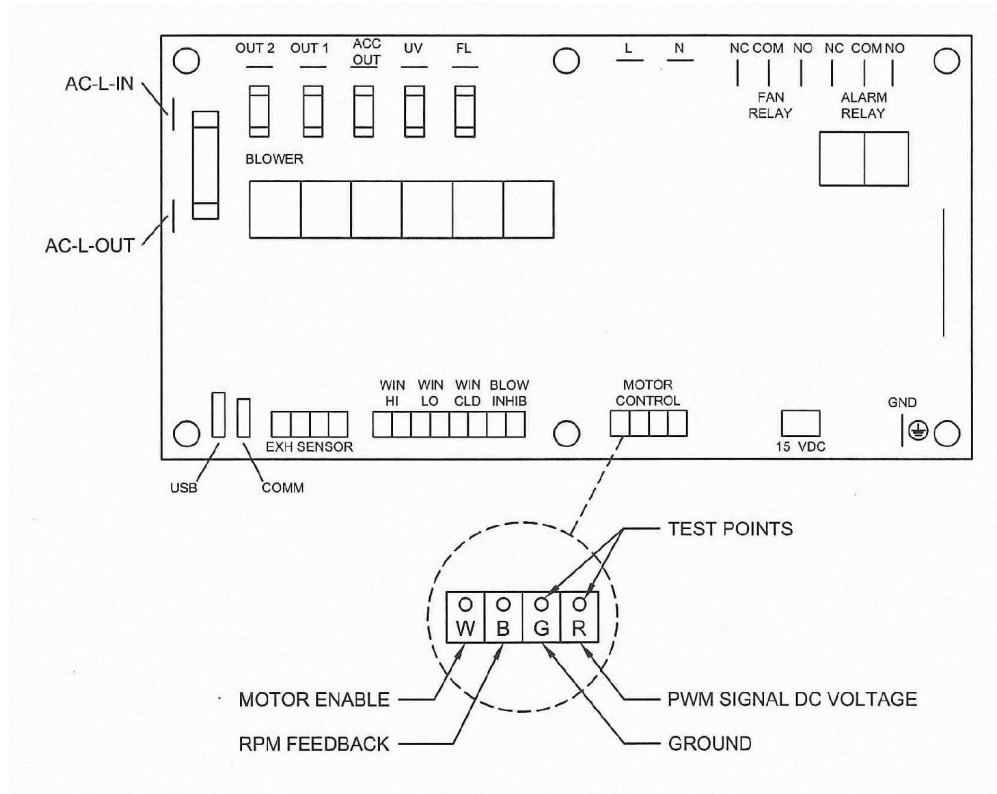

10.3 15VDC Output

The 15VDC (100mA) output is generated if the blower is actively running.

11.0 Electrical/Environmental Requirements

11.1 Electrical (Supply voltage fluctuations not to exceed +/- 10%)

NU-813-300/400/600	115Vac,	60Hz,	1 Phase, 5 Amps
NU-813-300E/400E/600E	230Vac,	50/60Hz,	1 Phase, 3 Amps

11.2 Operational Performance (for indoor use only)

Environment Temperature Range:	41°F-104°F (5°C - 40°C)
Environment Humidity:	Maximum relative humidity 80% for temperatures up to 31°C Decreasing linearly to 50% relative humidity at 40°C
Environment Altitude:	6562 Feet (2000 Meters) Maximum

11.3 Light Exposure

Standard Fluorescent Lighting @ 150 ft. candles (1614 LUX) maximum intensity.

11.4 Installation Category: II

Installation category (overvoltage category) defines the level of transient overvoltage which the instrument is designed to withstand safely. It depends on the nature of the electricity supply and its overvoltage protection means. For example, in CAT II, which is the category used for instruments in installations supplied from a supply comparable to public mains such as hospital and research laboratories and most industrial laboratories, the expected transient overvoltage is 2500 V for a 230 V supply and 1500 V for a 120 V supply.

11.5 Pollution Degree: 2.0

Pollution degree describes the amount of conductive pollution present in the operating environment. Pollution degree 2 assumes that normally only non-conductive pollution such as dust occurs with the exception of occasional conductivity caused by condensation.

11.6 Chemical Exposure

Chemical exposure should be limited to antibacterial materials used for cleaning and disinfecting. **CHLORINATED AND HALOGEN MATERIALS ARE NOT RECOMMENDED FOR USE ON STAINLESS STEEL SURFACES.** Equipment decontamination can be accomplished by non-condensing gas or vapor paraformaldehyde, Hydrogen Peroxide or Chlorine Dioxide following NSF/ANSI Annex G.

11.7 EMC Performance (classified for light industrial)

Emissions:	EN61326
Immunity:	EN61326



Class A equipment is intended for use in an industrial environment. In the documentation for the user, a statement shall be included drawing attention to the fact that there may be potential difficulties in ensuring electromagnetic compatibility in other environments, due to conducted as well as radiated disturbances.

 **Note:** The EMC performance requirements are generated within the product enclosure. The enclosure will be all metal grounded to earth. In addition, the membrane front panel will also include a ground plane for maximum protection and an electrostatic shield.

12.0 Disposal and Recycle

CVE's that are no longer in use and are ready for disposal contain reusable materials. ALL components with the exception of the HEPA filters may be disposed and/or recycled after they are known to be properly disinfected.

 **NOTE:** Follow local, state and federal guidelines for disposal of HEPA filter solid waste.



BIOHAZARD



CAUTION

Prior to any disassembly for disposal, the cabinet must be decontaminated.



RECYCLE



LEAD FREE

Component

Top Cabinet
 Worksurface
 Window
 Control Center
 Top Interior Panel
 Bottom Exterior Panel
 Exhaust Filter
 HEPA Filter Frames

Material

Painted Steel
 Epoxy Resin
 Polycarbonate
 Painted Steel
 Painted Steel
 Painted Steel
 Aluminum
 Stainless Steel and Plated Steel

Blower Wheel
 Motor
 Printed Wiring Assembly
 Wire
 Ballasts
 Armrest
 Connectors
 Hardware
 Workzone Side Panels
 Workzone Rear Panels

Plastic or Aluminum
 Various Steel/Copper
 Lead Free Electronic
 PVC Coated Copper
 Various Steel, Electronic
 Stainless Steel
 Nylon
 Stainless Steel and Steel
 Polycarbonate
 Polycarbonate

 **Note:** Material type can be verified with use of a magnet with stainless and aluminum being non-magnetic.

REV	ECO	DESCRIPTION	DATE	DFTM	CHKD
D	13515	ADDED COVER AND WASTE CHUTE DETAIL VIEWS	10/3/2017	TH	MSS

ITEM	PART NUMBER	DESCRIPTION
6	A-813-1570	COVER, CABLE
24	B-813-1522-TAB	WELDMENT, CONTROL BOX
27	B-813-1532-TAB	REAR DIVIDER PANEL
28	B-813-1533-TAB	FILLER ANGLE
29	B-813-1534-TAB	WORKZONE TOP PANEL
40	F-813-1404	ASSEMBLY, MAGNET HOUSING
47	X-980494-01	5/16 ACORN NUT
50	X-980609-03	8-32 X 1/2 SCREW
53	X-980619-04	8-32 X 3/4 SCR KNL SS
54	X-980667-01	5/16-18 X 3/4 BOLT
59	X-980790-04	WASHER FL 5/16 SAE ZINC

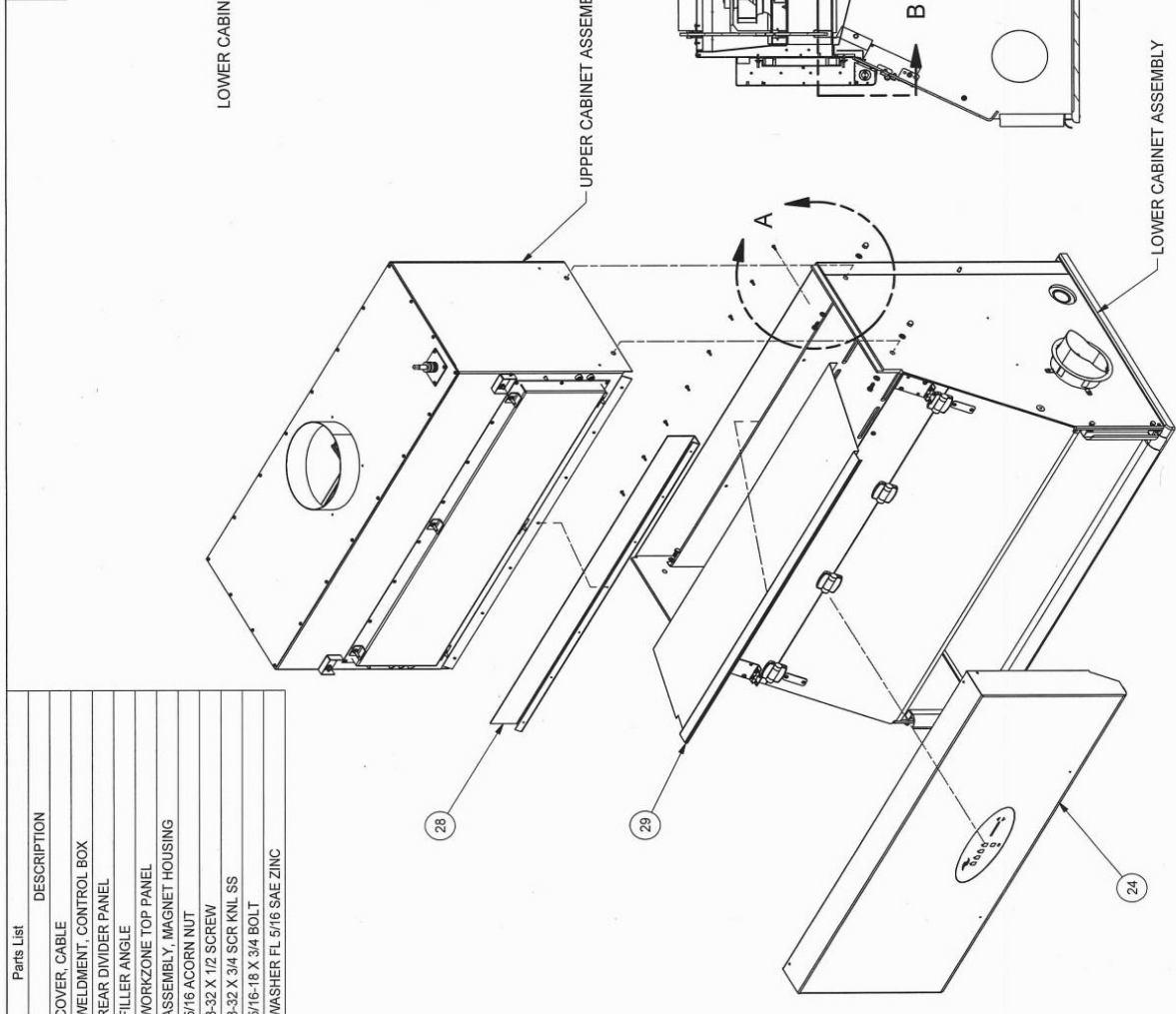

REV	ECO	DESCRIPTION	DATE	DFTM	CHKD
D	13515	ADDED COVER AND WASTE CHUTE DETAIL VIEWS	10/3/2017	TH	MSS

ORIGINAL

NU-813, SERIES 33
ASSEMBLY DRAWING

DFTM	DATE	CHKD	SHEET	1	OF	3
AW	10/22/2012	MSS				
DRAWING	NUMBER	BCD-15640				D

TABUNIT SIZE	MODEL	DATE	CHKD	SHEET	1	OF	3
-TAB	NU-813-300	AW	10/22/2012	MSS			
-01	NU-813-400						
-03	NU-813-600						

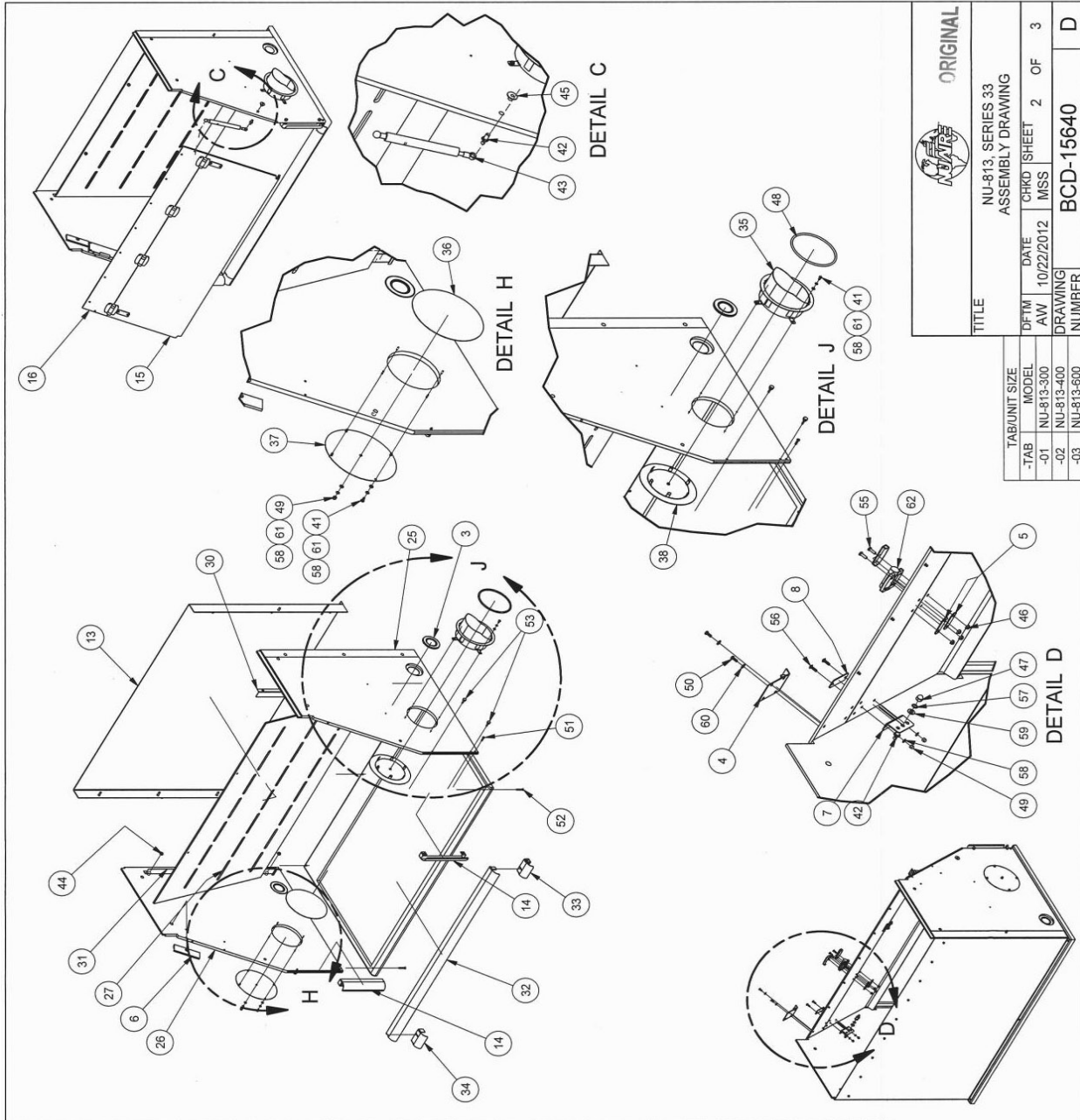

TITLE		NU-813, SERIES 33	
ASSEMBLY DRAWING		ORIGINAL	
DFTW	DATE	CHKD	SHEET
AW	10/22/2012	MSS	2 OF 3
DRAWING NUMBER		BCD-15640	
NU-813-400		D	
NU-813-500			

TAB/UNIT SIZE	MODEL
-TAB	NU-813-300
-01	NU-813-400
-02	NU-813-500
-03	

Parts List	
ITEM	PART NUMBER DESCRIPTION
3	A-540-737 CORD PASSTHRU MEMBRANE
4	A-813-1438 BRACKET, CONTROL BOX HINGE
5	A-813-1456 HINGE BACKING PLATE
6	A-813-1570 COVER, CABLE
7	A-813-469 BRACKET, LIFT
8	A-813-886 BACKUP PLATE, WINDOW LIFT
13	B-813-1248-TAB WELDMENT, BACK PANEL
14	B-813-1257 AIRFOIL SIDE
15	B-813-1399-TAB HINGED VIEW SCREEN
16	B-813-1403-TAB UPPER WINDOW
25	B-813-1531-01 PANEL RS
26	B-813-1531-02 PANEL LS
27	B-813-1532-TAB REAR DIVIDER PANEL
28	B-813-1533-TAB FILLER ANGLE
29	B-813-1534-TAB WORKZONE TOP PANEL
30	B-813-1535-01 ATTACHMENT ANGLE R. S.
31	B-813-1535-02 ATTACHMENT ANGLE L. S.
32	B-813-1581-TAB AIRFOIL FOR WORK SURFACE (REMOVABLE)
33	B-813-1582-01 AIRFOIL SIDE MOUNTING FLANGE RS
34	B-813-1582-02 AIRFOIL SIDE MOUNTING FLANGE LS
35	B-813-1585 ASSEMBLY, CHUTE
36	B-813-1586 PORT COVER, INSIDE
37	B-813-1587 PORT COVER, OUTSIDE
38	B-813-1590 ASSEMBLY, PORT COVER
41	X-980038-01 8-32 X 3/8 PPHMS
42	X-980185 5/16-18 BALLSTUD
43	X-980250-04 WINDOW RAM
44	X-980430-02 LKNUIT 1/4-20 SERR FLNG ZINC
45	X-980432-01 NUT, T 5/16-18UNC PLAIN
46	X-980490-09 10-24 SST LOCKNUT
47	X-980494-01 5/16 ACORN NUT
48	X-980505-24 O-RING 5.60" ID 70A BUNA-N
49	X-980510 ACORN NUT, 8-32 SST
50	X-980609-03 8-32 X 1/2 SCREW
51	X-980609-05 8-32 X .750 PPH
52	X-980609-06 SCR PPH 8-32 X 1-1/4 SST
53	X-980619-04 8-32 X 3/4 SCR KNL SS
55	X-980692-02 #10-24 X .750 HEX HD (SST)
56	X-980724-03 SCREW, TRUSS - 8-32 X .750
57	X-980781-06 5/16 LOCK WASHER
58	X-980783-03 #8 SST FLAT WASHER
59	X-980790-04 WASHER FL 5/16 SAE ZINC
60	X-980794-01 #8 INT. TOOTH LOCK WASHER
61	X-980815-03 WINDOW HINGE
62	X-980906-02 WINDOW HINGE

ITEM	PART NUMBER	DESCRIPTION
1	A-430-2217	WELDMENT COUPLING MOUNTING PLATE
2	A-480-9037	CONTROL BOX BRACKET
9	A-980939-15	HEPA 14X28X6 AL FR BEAD PACK (-300 / -600 (2))
10	A-980939-16	HEPA 14X41X6 AL FR BEAD PACK-400
11	A-980939-20	HEPA 14X28X3 AL FR BEAD PACK (-300 / -600 (2))
12	A-980939-21	HEPA 14X41X3 AL FR BEAD PACK-400
17	B-813-1415-TAB	WELDMENT, TOP PANEL
18	B-813-1417-TAB	SEAL FLANGE BI / BO (-600 (2))
19	B-813-1420-TAB	WELDMENT, BI / BO COVER (-600 (2))
20	B-813-1423-TAB	WELDMENT, PLATE, EG, IMPELLER (-600 (2))
21	B-813-1428-TAB	BAG ASSEMBLY, SINGLE FILTER 613 (-600 (2))
22	B-813-1431-TAB	ASSEMBLY, CHAIN RACK (-600 (2))
23	B-813-1443-TAB	ASSEMBLY, FILTER SPACER PLENUM (-600 (2))
39	F-425-3897	ASSY. SCREW W/CAPTIVE O-RING
44	X-980430-02	LKNUT 1/4-20 SERR FLNG ZINC
50	X-980609-03	8-32 X 1/2 SCREW
63	X-995148-17	ASSY. IMPELLER & HARNESS
64	X-995260-02	SEAL, CORD CRIMP

(STANDARD) Parts List

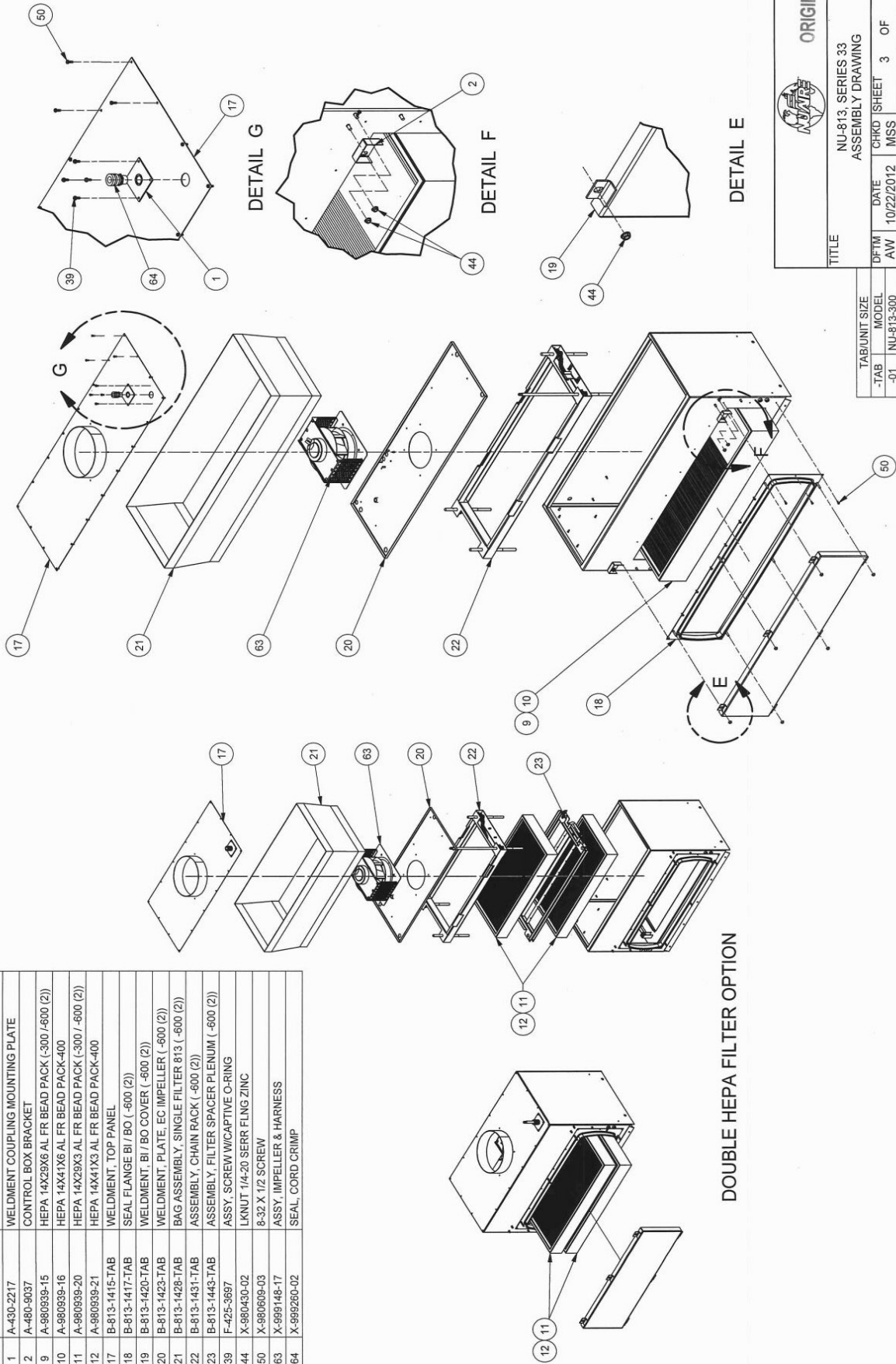

DOUBLE HEPA FILTER OPTION

 ORIGINAL	
TITLE	
NU-813, SERIES 33	
ASSEMBLY DRAWING	
DFTM	DATE
AW	10/22/2012
MSS	3 OF 3
DRAWING NUMBER	BCD-15640
NU-813-600	D

TAB/UNIT SIZE	MODEL
-TAB	NU-813-300
-01	NU-813-400
-02	NU-813-600
-03	

REV	ECO	DESCRIPTION	DATE	DFTM	CHKD
E	13902	UPDATED HARDWARE	11/15/2018	TH	DSH

ITEM	QTY	PART NUMBER	DESCRIPTION
1		A-425-7373	BRACE LATERAL, BSC
2		A-500-395	BUSHING, BASE STAND LEG
3		B-400-9562	WELDMENT, END PANEL, BASESTAND (28')
4		B-500-390	LEG EXTENSION, BASE STAND
5	1	B-500-391-TAB	WELDMENT, CROSS MEMBER PANEL 3 FT.
6	4	B-800-1579	LEG EXTENSION, BASE STAND EXTENDED HEIGHT
7	1	B-813-1510-01	BRACKET, 813 BASE STAND, FRONT LEFT
8	1	B-813-1510-02	BRACKET, 813 BASE STAND, FRONT RIGHT
9	1	B-813-1511-01	BRACKET, 813 BASE STAND, REAR LEFT
10	1	B-813-1511-02	BRACKET, 813 BASE STAND, REAR RIGHT
11	4	X-980443	LEG LEVELER FOR 2" SQ TUBING
12	8	X-980493	ACORN NUT, 1/4-20
13	8	X-980494-03	NUT, ACORN 3/8-16 18-8 SST
14	8	X-980495	1/4-20 NUTSERT
15	4	X-980609-06	SCR PPH 8-32 X 1-1/4 SST
16	20	X-980659-12	SCREW, HHCS, 1/4-20 X 5/8 18-8 SST
17	8	X-980781-07	3/8 LOCK WASHER
18	4	X-980783-03	#8 SST FLAT WASHER
19	16	X-980783-07	WASHER FL 3/8 SAE NKL
20	28	X-980794-02	1/4 SST FLAT WASHER
21	20	X-980815-01	1/4 INTERNAL TOOTH LOCK WASHER
22	8	X-980929-01	BOLT 3/8-16 X 2-3/4 SST

REV	ECO	DESCRIPTION	DATE	DFTM	CHKD
E	13902	UPDATED HARDWARE	11/15/2018	TH	DSH



BOLT THRU THESE (2) HOLES FOR 36" WORK SURFACE HEIGHT

BOLT THRU THESE (2) HOLES FOR 30" WORK SURFACE HEIGHT

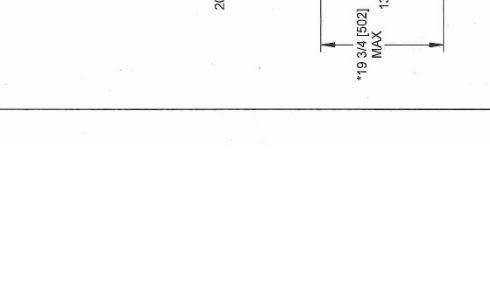
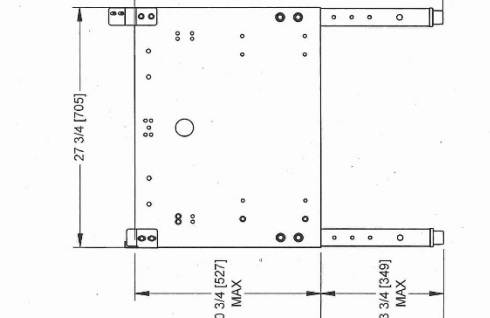
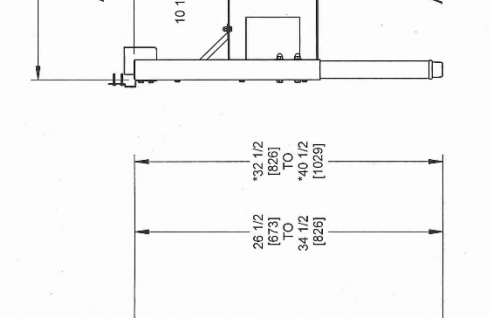
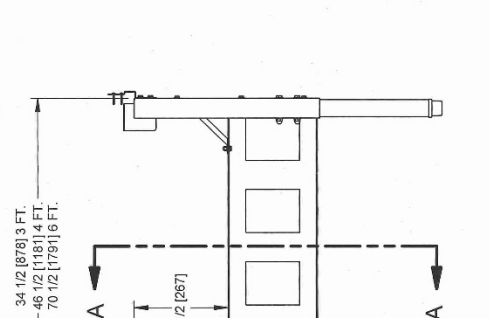
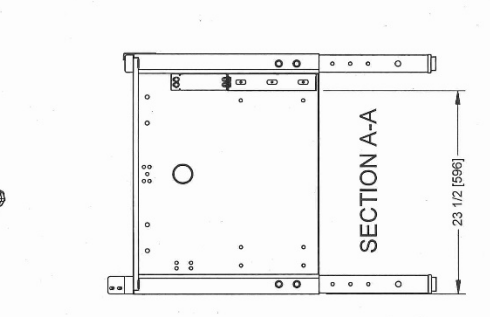
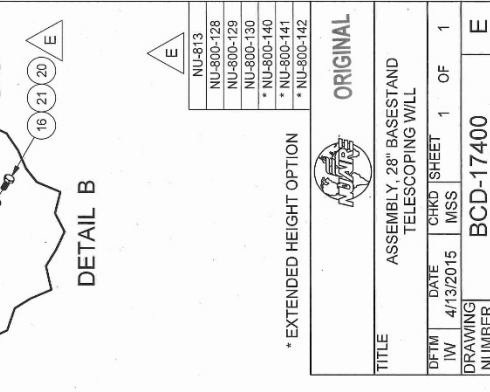

NU-813	NU-800-128	NU-800-129	NU-800-130	* NU-800-140	* NU-800-141	* NU-800-142
--------	------------	------------	------------	--------------	--------------	--------------

* EXTENDED HEIGHT OPTION

ORIGINAL

TITLE: ASSEMBLY, 28" BASESTAND TELESCOPING WILL

DFTM: IW DATE: 4/13/2015 CHD: MSS SHEET: 1 OF 1

DRAWING NUMBER: BCD-17400

REV	ECO	DESCRIPTION	DATE	DFTM	CHKD
H	13902	UPDATED HARDWARE	11/15/2018	TH	DSH

REV	ECO	DESCRIPTION	DATE	DFTM	CHKD
H	13902	UPDATED HARDWARE	11/15/2018	TH	DSH

ITEM	QTY	PART NUMBER	3 FT.	4 FT.	6 FT.	DESCRIPTION
1	2	A-425-7373				BRACE LATERAL, BSC
2	8	A-500-395				BUSHING, BASE STAND LEG
3	2	B-400-9562				WELDMENT, END PANEL, BASESTAND (28")
4	1	B-500-391-TAB	-01	-02	-04	WELDMENT, CROSS MEMBER PANEL 3 FT.
5	4	B-500-507				WELDMENT, LEG EXTENSION (CASTOR)
6	4	B-620-2285				BASESTAND, LEG EXTENSION (CASTOR) EXTENDED HEIGHT
7	*4	B-800-1577				WELDMENT, LEG EXTENSION (CASTOR) EXTENDED HEIGHT
8	1	B-813-1510-01				BRACKET, 813 BASE STAND, FRONT LEFT
9	1	B-813-1510-02				BRACKET, 813 BASE STAND, FRONT RIGHT
10	1	B-813-1511-01				BRACKET, 813 BASE STAND, REAR LEFT
11	1	B-813-1511-02				BRACKET, 813 BASE STAND, REAR RIGHT
12	4	X-980040-08				CASTOR, SWIVEL W/ BRACKET, 4" SST
13	16	X-980490-06				NUT HEX 5/16 - 18, FINISHED, SST
14	8	X-980493				ACORN NUT, 1/4-20
15	8	X-980494-03				NUT, ACORN 3/8-16 18-8 SST
16	4	X-980495				1/4-20 NUTSERT
17	4	X-980609-06				SCR PPH 8-32 X 1-1/4 SST
18	20	X-980659-12				SCREW, HHCS, 1/4-20 X 5/8 18-8 SST
19	16	X-980781-07				5/16-18 X 3/4 BOLT
20	8	X-980781-07				3/8 LOCK WASHER
21	4	X-980783-03				#8 SST FLAT WASHER
22	16	X-980783-07				WASHER FL 3/8 SAE NKL
23	32	X-980790-06				WASHER FL 5/16 SAE SST
24	28	X-980794-02				1/4 SST FLAT WASHER
25	16	X-980795-05				WASHER LK 5/16" SPLIT 18-8 SST
26	20	X-980815-01				1/4 INTERNAL TOOTH LOCK WASHER
27	8	X-980929-01				BOLT 3/8-16 X 2-3/4 SST

Parts List

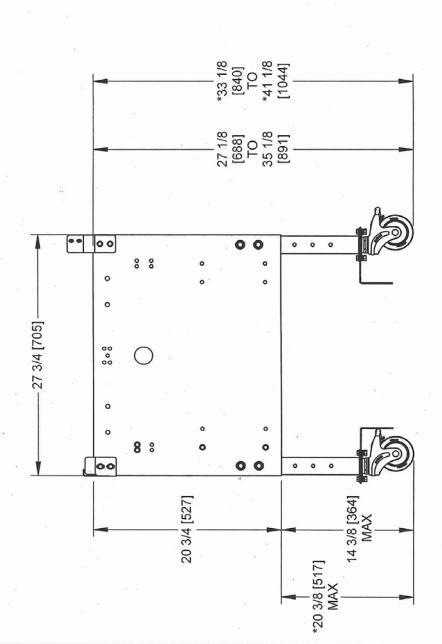
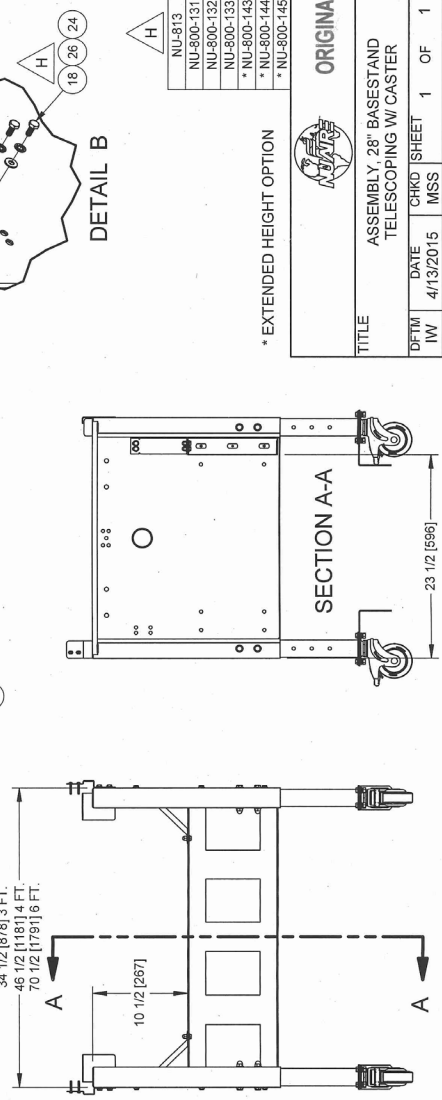
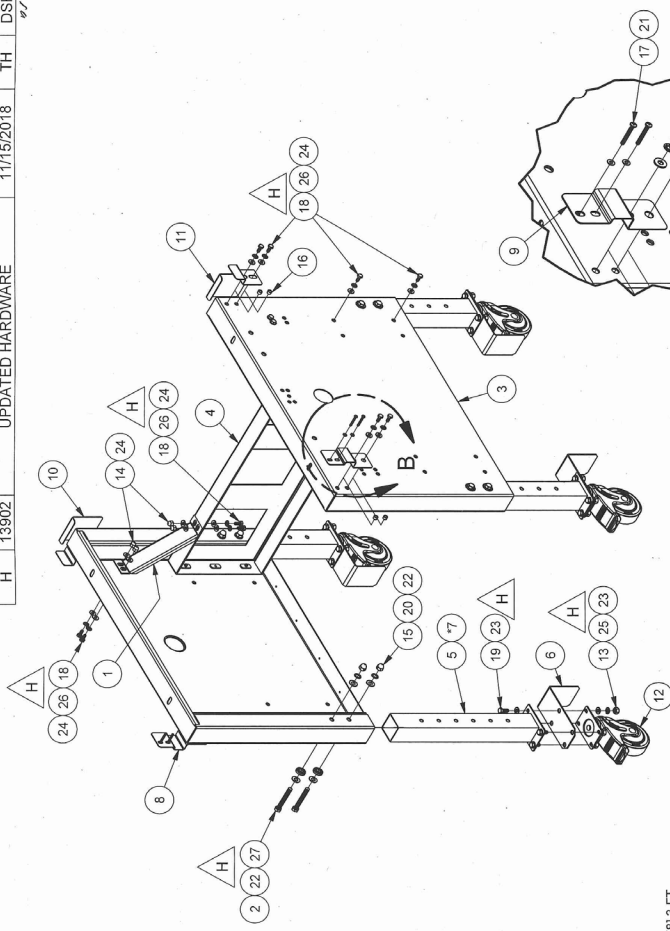

NU-813
NU-800-131
NU-800-132
NU-800-133
* NU-800-143
* NU-800-144
* NU-800-145

* EXTENDED HEIGHT OPTION

ORIGINAL	
TITLE ASSEMBLY, 28" BASESTAND TELESCOPING W/CASTER	
DFTM	DATE
IW	4/13/2015
MSS	1 OF 1
DRAWING NUMBER	BCD-17401

REV	ECO	DESCRIPTION	DATE	DFTM	CHKD
A	11492	RELEASED TO PRODUCTION	1/16/2012	DHH	BP

REFERENCE EXHAUST REQUIREMENTS			TOTAL
MODEL	EXHAUST VOLUME AT 80 FPM	AIR GAP VOLUME	243 CFM
NU-813-300	195 CFM	48 CFM	308 CFM
NU-813-400	260 CFM	48 CFM	308 CFM
NU-813-600	390 CFM	48 CFM	438 CFM

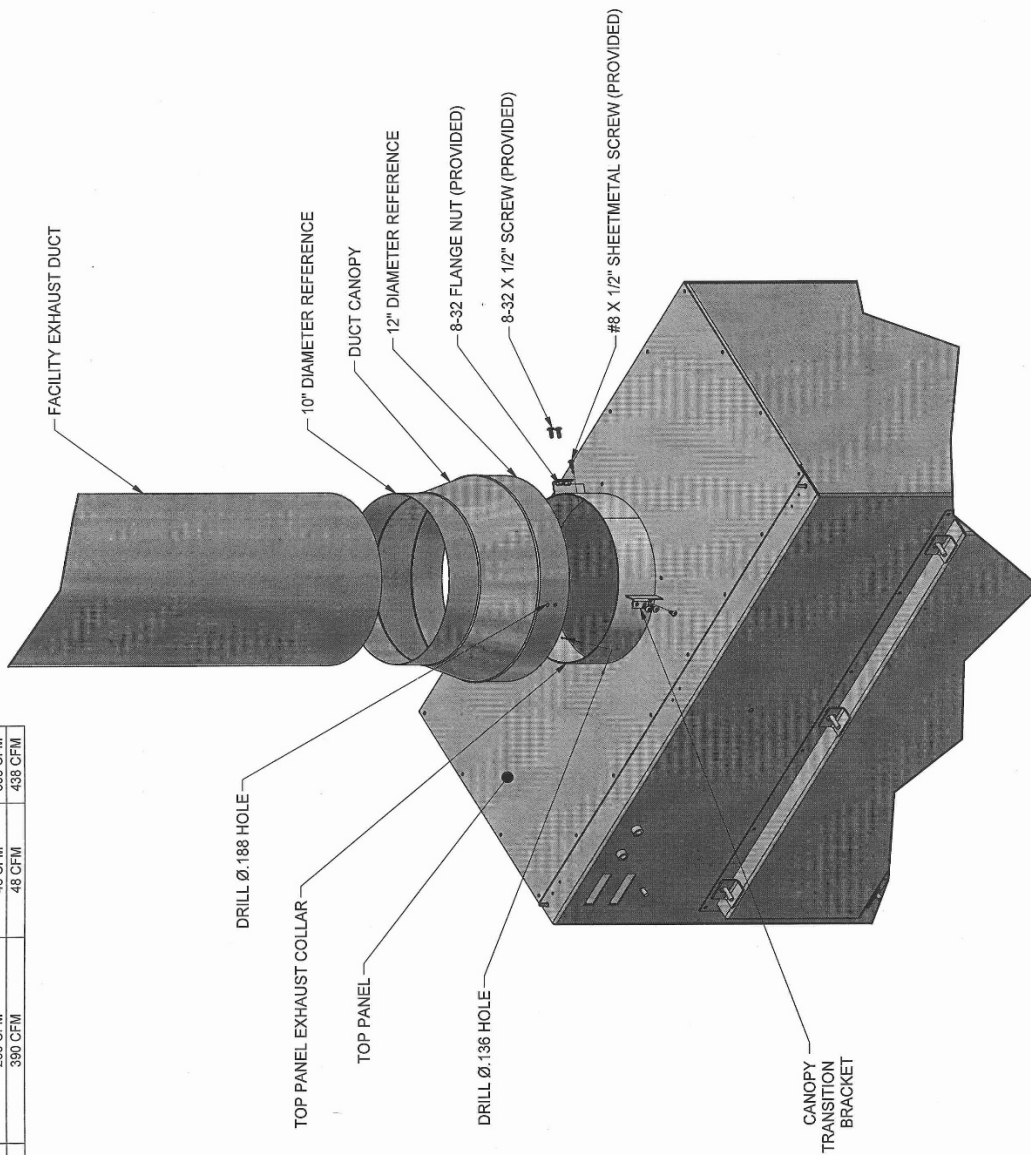

INSTALLATION

- 1) LOCATE CANOPY TRANSITION BRACKET IN (3) EQUAL DISTANT SPACES (120°) AROUND 12 INCH DIAMETER CIRCUMFERENCE OF DUCT CANOPY. POSITION WITH BOTTOM OF CANOPY TRANSITION BRACKET FLANGE FLUSH WITH BOTTOM OF DUCT CANOPY.
- 2) DRILL ϕ .188 HOLES (QTY: 6) AND FASTEN BRACKETS WITH 8-32 X 1/2" SCREWS AND NUTS PROVIDED.
- 3) REMOVE TOP PANEL FROM NU-813 AND LOCATE DUCT CANOPY ON TOP PANEL EXHAUST COLLAR MARKING ONE HOLE LOCATION ON EACH BRACKET.
- 4) DRILL ϕ .136 HOLES (QTY: 3, ONLY ONE REQUIRED PER BRACKET) IN TOP PANEL EXHAUST COLLAR AND FASTEN DUCT CANOPY BRACKETS WITH #8 X 1/2" SHEETMETAL SCREWS PROVIDED.
- 5) RE-ATTACH TOP PANEL AND CONNECT FACILITY EXHAUST DUCT.

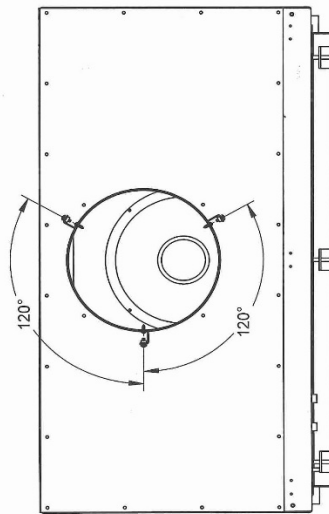

TITLE
FIXED RANGE DUCT CANOPY
INSTALLATION INSTRUCTIONS

DFTM
DHH 1/16/2012

CHRD (SHEET)
BP 1 OF 1

DRAWING
NUMBER

BCD-15071

INCH
MILLIMETER

ORIGINAL

NOTE:
REMOVE TOP PANEL FROM UNIT TO DRILL DUCT CANOPY MOUNTING HOLES TO AVOID METAL PARTICLES FROM DROPPING INTO BLOWER/HEPA FILTER.

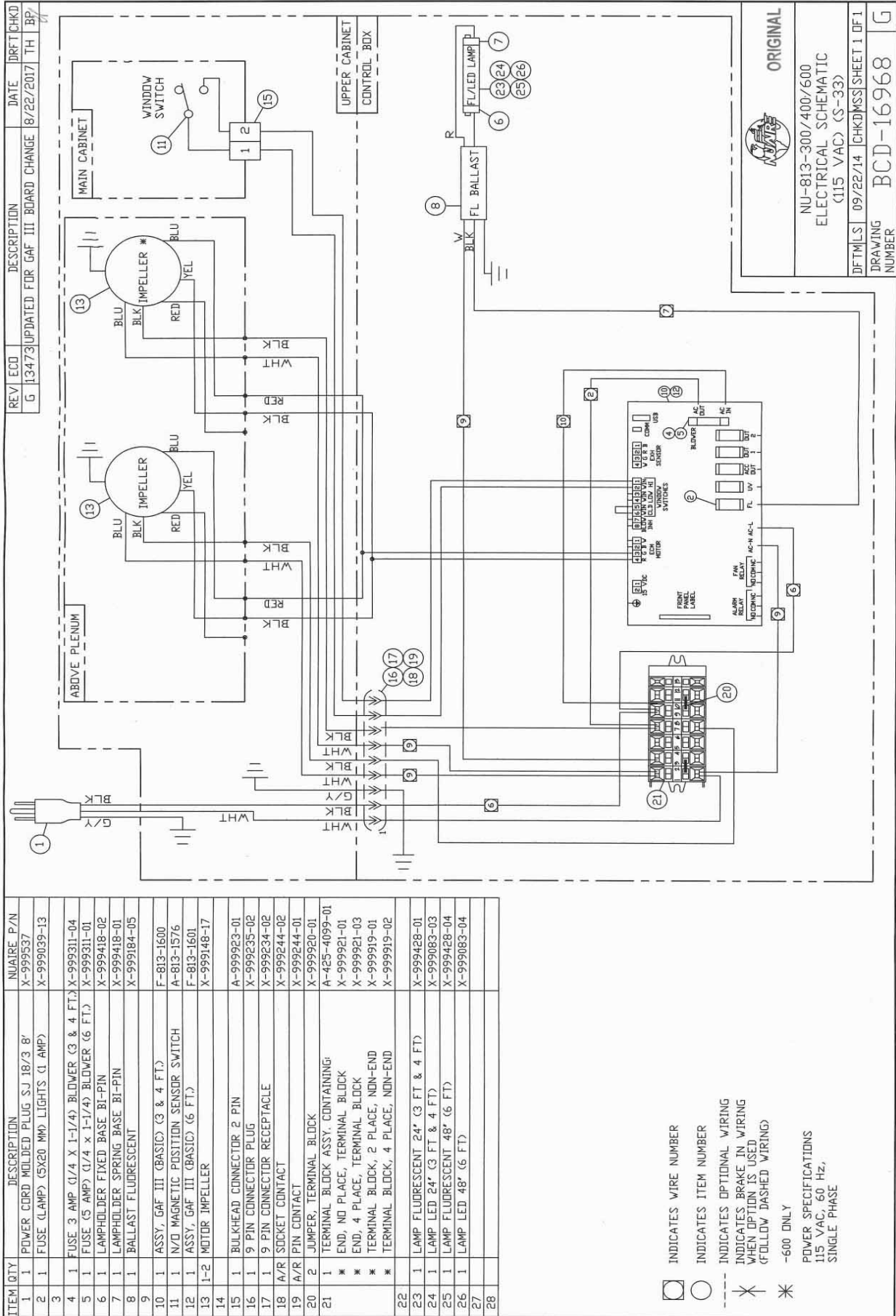

ORIGINAL
 NU-813-300/400/600
 ELECTRICAL SCHEMATIC
 (115 VAC) (S-33)
 DFTMLS 09/22/14 (CHKDMS) SHEET 1 OF 1
 DRAWING NUMBER BCD-16968 G

ITEM QTY	DESCRIPTION	NUAIRE P/N
1 1	POWER CORD MOLDED PLUG SJ 18/3 B'	X-999537
2 1	FUSE (LAMP) (5X20 MM) LIGHTS (1 AMP)	X-999039-13
3		
4 1	FUSE 3 AMP (1/4 X 1-1/4) BLOWER (3 & 4 FT.)	X-999311-04
5 1	FUSE (5 AMP) (1/4 X 1-1/4) BLOWER (6 FT.)	X-999311-01
6 1	LAMPHOLDER FIXED BASE BI-PIN	X-999418-02
7 1	LAMPHOLDER SPRING BASE BI-PIN	X-999418-01
8 1	BALLAST FLUORESCENT	X-999184-05
9		
10 1	ASSY, GAF III (BASIC) (3 & 4 FT.)	F-813-1600
11 1	N/O MAGNETIC POSITION SENSOR SWITCH	A-813-1576
12 1	ASSY, GAF III (BASIC) (6 FT.)	F-813-1601
13 1-2	MOTOR IMPELLER	X-999148-17
14		
15 1	BULKHEAD CONNECTOR 2 PIN	A-999923-01
16 1	9 PIN CONNECTOR PLUG	X-999235-02
17 1	9 PIN CONNECTOR RECEPTACLE	X-999234-02
18	A/R SOCKET CONTACT	X-999244-02
19	A/R PIN CONTACT	X-999244-01
20 2	JUMPER, TERMINAL BLOCK	X-999920-01
21	TERMINAL BLOCK ASSY. CONTAINING: END, NO PLACE, TERMINAL BLOCK END, 4 PLACE, TERMINAL BLOCK TERMINAL BLOCK, 2 PLACE, NON-END TERMINAL BLOCK, 4 PLACE, NON-END	A-425-4099-01 X-999921-01 X-999921-03 X-999919-01 X-999919-02
22		
23 1	LAMP FLUORESCENT 24" (3 FT & 4 FT)	X-999428-01
24 1	LAMP LED 24" (3 FT & 4 FT)	X-999083-03
25 1	LAMP FLUORESCENT 48" (6 FT)	X-999428-04
26 1	LAMP LED 48" (6 FT)	X-999083-04
27		
28		

□ INDICATES WIRE NUMBER
 ○ INDICATES ITEM NUMBER
 - - - INDICATES OPTIONAL WIRING
 * INDICATES BRAKE IN WIRING WHEN OPTION IS USED (FOLLOW DASHED WIRING)
 * -600 ONLY
 POWER SPECIFICATIONS
 115 VAC, 60 Hz,
 SINGLE PHASE

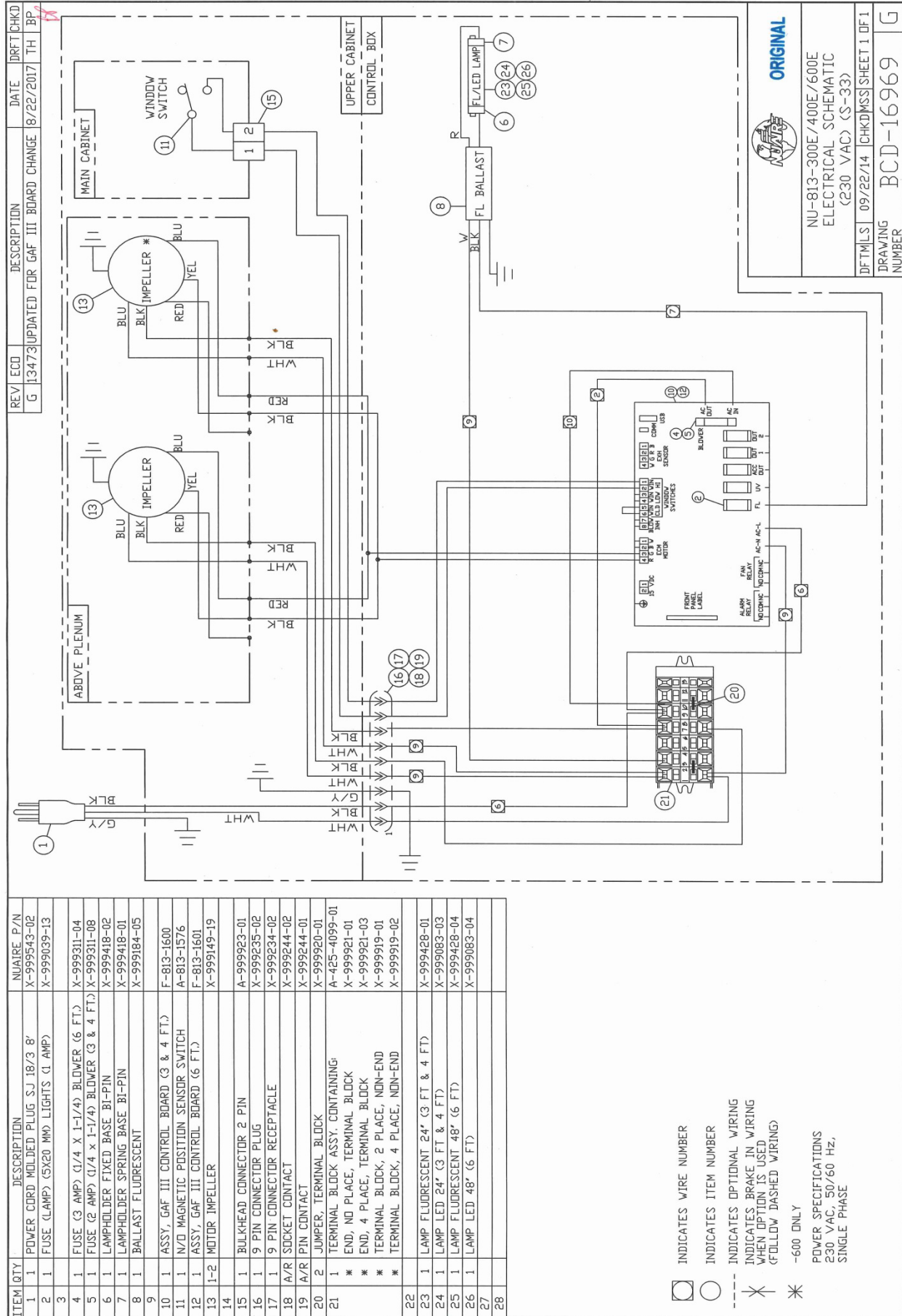

ORIGINAL
 NU-813-300E/400E/600E
 ELECTRICAL SCHEMATIC
 (230 VAC) (S-33)
 DFTM|S 09/22/14 |CHKD|MSS|SHEET 1 OF 1
 DRAWING NUMBER BCD-16969 G